



Hydra RQT

Mold Temperature Controllers

Operation, Installation & Maintenance Manual



IMS Company

10373 Stafford Rd • Chagrin Falls, OH 44023 • 1.800.537.5375 • FAX: 440.543.1069
sales@imscompany.com • www.imscompany.com

Please record your equipment's model and serial number(s) and the date you received it in the spaces provided.

It's a good idea to record the model and serial number(s) of your equipment and the date you received it in the User Guide. Our service department uses this information, along with the manual number, to provide help for the specific equipment you installed.

Please keep this User Guide and all manuals, engineering prints, and parts lists together for documentation of your equipment.

Date:

Serial Number(s):

Model Number(s):

DISCLAIMER: Neither **IMS Company** nor its employees shall be liable for errors contained in this User Guide or for incidental, consequential damages in connection with the furnishing, performance or use of this information. Thermal Care makes no warranty of any kind with regard to this information, including, but not limited to, the implied warranties of merchantability and fitness for a particular purpose.

Table of Contents

1 - 1 Introduction

Purpose of the User Guide.....	1-2
How the Guide is Organized	1-2
Your Responsibility as a User	1-2
Foreword	1-3
ATTENTION: Read This So No One Gets Hurt.....	1-4
Zero Energy State (ZES)	1-5
How to Use the Lockout Device (if Equipped)	1-6

2 - 1 Description

What is the RQT Advanced	2-2
Typical Applications	2-2
How the RQT Advanced Direct Injection Works	2-4
How the Closed Circuit Common Source Works.....	2-5
RQT Advanced Control Features vs RQT Premium and RQT Standard	2-6
Specifications: RTQ Advancee	2-7

3 - 1 Installation

Unpacking the Boxes	3-2
Preparing for Installation.....	3-3
Fluid Distribution Piping	3-6
Installation - Electrical	3-7
Connecting Process and Water Supply Lines <u>Without</u> Purge.....	3-8
Connecting Process and Water Supply Lines <u>With</u> Optional Mold Purge Valve Connections.....	3-9
Connecting the Main Power Source.....	3-10
Testing the Installation	3-11
Initial Setup	3-12
Setpoint.....	3-14
Setting Process Value Source.....	3-14
Setting Up Your Controller	3-15

4 - 1 Operation

The RQT Advanced Control.....	4-2
Start-up.....	4-3
Starting the RQT Advanced	4-4
Stopping the RQT Advanced.....	4-5
Normal Operation.....	4-6
Auto Cool Stop Sequence Initiation.....	4-6
Using the Optional Mold Purge Option	4-7

5 - 1 Maintenance

Maintenance of Your RQT Advanced	5-2
Preventative Maintenance Schedule.....	5-2
Accessing the RQT Advanced Enclosure.....	5-3
Removing the Pump Motor and Seal (3/4-2 HP, any frequency and 3HP, 60 Hz units).....	5-4
Reassembling the Pump Motor and Seal (3/4-2 HP, any frequency and 3HP, 60 Hz units)	5-7
Removing the Pump Motor and Seal (3 HP, 50Hz and 5 to 10 HP, any frequency units).....	5-9
Reassembling Pump Motor and Seal (3 HP, 50Hz and 5 to 10 HP, any frequency units).....	5-11
Resetting Pump Overload.....	5-12
Replacing Pump Overload	5-12
Replacing the Heater Contactor.....	5-13
Replacing the Controller Boards	5-14
System Maintenance	5-14
RQT Advanced Controller Abbreviations/Acronyms	5-15
Diagnostics Screens	5-15
Replacing RTDs	5-16
Repairing Cooling Valves.....	5-17
Replacing Immersion Heaters	5-18
Removing the Pump.....	5-22

6-1 Troubleshooting

Before Beginning 6-2
A Few Words of Caution 6-3
Identifying the Cause of a Problem..... 6-4
Controller Warnings 6-5
Controller Alarms 6-7
Unit Will Not Power Up 6-10
Troubleshooting 6-11
Replacing the Heater Contactor..... 6-13
Checking the RTD 6-13

A Appendix

We're Here to Help..... A-1
How to Contact Customer Service..... A-1
Before You Call..... A-1

B Appendix

PID Parameters..... B-1

C Appendix

Plumbing Diagrams C-1
Plumbing Curves C-5

D Appendix

External Interfaces..... D-1

E Appendix

Flowmeter Installation Instruction Sheet..... E-1

F Appendix

Modbus Parameters.....F-1

Introduction

Purpose of the User Guide	1-2
How the Guide is Organized	1-2
Your Responsibility as a User	1-2
Foreword	1-3
ATTENTION: Read This So No One Gets Hurt	1-4
Zero Energy State (ZES).....	1-5
How to Use the Lockout Device (if Equipped).....	1-6

Purpose of the User Guide

This User Guide describes the IMS Hydra RQT Advanced and explains step-by-step how to install and operate this equipment.

Before installing this product, please take a few moments to read the User Guide and review the diagrams and safety information in the instruction packet. You also should review manuals covering associated equipment in your system. This review won't take long, and it could save you valuable installation and operating time later.

How the Guide is Organized

Symbols have been used to help organize the User Guide and call your attention to important information regarding safe installation and operation.



Symbols within triangles warn of conditions that could be hazardous to users or could damage equipment. Read and take precautions before proceeding.



Numbers indicate tasks or steps to be performed by the user.



A diamond indicates the equipment's response to an action performed by the user or a situation.



An open box marks items in a checklist.



A circle marks items in a list.



Indicates a tip. A tip is used to provide you with a suggestion that will help you with the maintenance and the operation of this equipment.



Indicates a note. A note is used to provide additional information about the steps you are following throughout the manual.

Your Responsibility as a User

You must be familiar with all safety procedures concerning installation, operation, and maintenance of this equipment. Responsible safety procedures include:

- Thorough view of this User Guide, paying particular attention to hazard warnings, appendices, and related diagrams.
- Thorough review of the equipment itself, with careful attention to voltage sources, intended use, and warning labels.
- Thorough review of instruction manuals for associated equipment.
- Step-by-step adherence to instructions outlined in this User Guide.

Foreword

The RQT Advanced typically consists of a fluid pump, electric immersion heater, and temperature control valve in a compact packaged cabinet for easy location in industrial applications where fluid temperature control is required.

This manual is to serve as a guide for installing, operating, and maintaining the equipment. Improper installation can lead to poor performance and/or equipment damage. We recommend the use of qualified installers and service technicians for all installation and maintenance of this equipment.

This manual is for our standard product - in this case, the RQT Advanced TCU equipped with the an (Enhanced) control. The information in this manual is general in nature. Unit-specific drawings and supplemental documents are included with the equipment as needed. Additional copies of documents are available upon request. We strive to maintain an accurate record of all equipment during the course of its useful life.

Due to the ever-changing nature of applicable codes, ordinances, and other local laws pertaining to the use and operation of this equipment, we do not reference them in this manual. There is no substitute for common sense and good operating practices when placing any mechanical equipment into operation. We encourage all personnel to familiarize themselves with this manual's contents. Failure to do so may unnecessarily prolong equipment down time.

Follow good piping practices and the information in this manual to ensure successful installation and operation of this equipment.

We trust your equipment will have a long and useful life. If you should have any questions, please contact our Customer Service Department specifying the serial number and model number of the unit as indicated on the nameplate.

ATTENTION:

Read This So No One Gets Hurt

We design equipment with the user's safety in mind. You can avoid the potential hazards identified on this machine by following the procedures outlined below and elsewhere in the User Guide.



WARNING: Improper installation, operation, or servicing may result in equipment damage or personal injury.



This equipment should be installed, adjusted, and serviced by qualified technical personnel who are familiar with the construction, operation, and potential hazards of this type of machine.

All wiring, disconnects, and fuses should be installed by qualified electrical technicians in accordance with electrical codes in your region. Always maintain a safe ground. Do not operate the equipment at power levels other than what is specified on the machine serial tag and data plate.



WARNING: Voltage Hazard



This equipment is powered by three-phase alternating current, as specified on the machine serial tag and data plate.

A properly sized conductive ground wire from the incoming power supply must be connected to the chassis ground terminal inside the electrical enclosure. Improper grounding can result in severe personal injury and erratic machine operation.

Always disconnect and lock out the incoming main power source before opening the electrical enclosure or performing non-standard operating procedures, such as routine maintenance. Only qualified personnel should perform troubleshooting procedures that require access to the electrical enclosure while power is on.



WARNING: Compressed Air Hazard

If you use compressed air, you must wear eye protection and observe all OSHA and other safety regulations pertaining to the use of compressed air. Bleed off pressure before servicing equipment.



CAUTION: Hot Surfaces



Surface temperatures inside the RQT Advanced can exceed 300°F {149°C}. Always allow the unit to cool below 100°F {38°C} before opening, servicing, or disassembling the unit.

Zero Energy State (ZES)



CAUTION: Before performing maintenance or repairs on this product, you should disconnect and lockout electrical power sources to prevent injury from unexpected energizing or start-up.

During maintenance, it is essential that the system be put into a state which eliminates the possibility of components making an unexpected and dangerous movement. This procedure is typically referred to as lockout. After all energy sources have been neutralized, the system is in the zero mechanical state (ZMS). This provides maximum protection against unexpected mechanical movement.

The lockout procedure must include all energy sources:

- Electrical power supply
- Compressed air supply
- Potential energy from suspended parts
- Pressurized process fluid loop
- Cooling fluid supply
- Cooling fluid return
- Stored thermal energy
- Any other source that might cause unexpected mechanical movement or energy release

The following is a recommended Zero Energy State procedure which must be followed prior to any inspection, or maintenance of the TCU.

- 1 Turn off the all devices attached to the RQT Advanced.**
- 2 Perform the proper shutdown sequence to the connected equipment** and allow all components (internally and externally) to adequately cool.
- 3 Disconnect and lock out the primary electrical supply feeding all attached components.**



WARNING: Before removing lockout devices and returning switches to the ON position, make sure that all personnel are clear of the machine, tools have been removed and all safety guards reinstalled.

- 4 Disconnect and lock out the compressed air supply (if equipped).**
- 5 Isolate the RQT Advanced** from other fluids in the system, such as the main process loop and the cooling fluid supply and return.
- 6 Bleed off fluid pressure** that may be present in the various fluid containing portions of the RQT Advanced, keeping in mind that pressure can be the result of increased temperatures

How to Use the Lockout Device (if Equipped)

 **CAUTION:** Before performing maintenance or repairs on this product, you should disconnect and lockout electrical power sources to prevent injury from unexpected energization or start-up. A lockable device may be provided to isolate this product from potentially hazardous electricity.

 **WARNING:** Before removing lockout devices and returning switches to the ON position, make sure that all personnel are clear of the machine, tools have been removed and all safety guards reinstalled.

Lockout is the preferred method of isolating machines or equipment from energy sources. Your IMS Company product may be equipped with the lockout device pictured below. To use the lockout device:

- 1 Stop or turn off the equipment.**
- 2 Isolate the equipment from the electric power.**
- 3 Turn the rotary disconnect switch to the OFF, or “O” position**
- 4 Secure the device with an assigned lock or tag.**
- 5 The equipment is now locked out.**

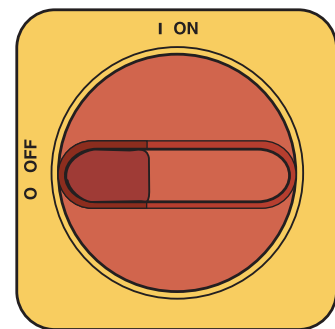
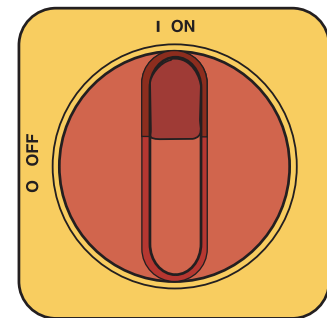
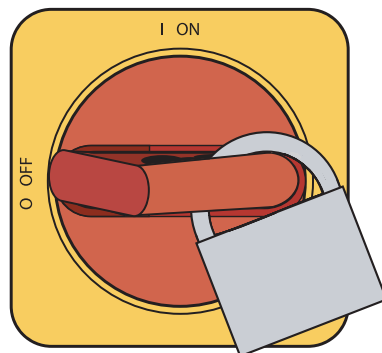

If the machine has no included lockout device, perform the same procedure at the upstream device as part of premises electrical system. Incoming cooling water and compressed air (if purge) are additional energy sources that need to be controlled.

 **NOTE:** The incoming power wires on the top of the disconnect switch are still energized, even when the machine is locked out. It is strongly recommended that electrical energy also be locked out at the next upstream device if work is going to be performed in the electrical panel.

Description

What is the RQT Advanced 2-2

Typical Applications 2-2

How the RQT Advanced Direct Injection Works 2-4

How the Closed Circuit Common Source Works 2-5

RQT Advanced Control Features vs RQT Advanced and
RQT Premium 2-6

Specifications: RQT Advanced 2-7

What is the RQT Advanced

The RQT Advanced circulate water at a temperature higher than the available water supply. It will add or remove heat as needed to maintain a uniform temperature setpoint in the process.

The RQT Advanced is available in single or multiple-zone configurations for process heating and cooling. Two-zone models can control up to two temperatures at different locations in the process. Two-zone models have common cooling water manifolds and electrical connections.



Typical Applications

The best model for your application depends on the process temperature you need to maintain and the quality of the cooling water supply.

RQT Advanced direct injection (DI) models control the temperature by discharging heated process water or adding cooling water directly from the water supply. DI models are designed for:

- Process temperatures up to 250°F {121°C} - with options up to 300°F {149°C}.
- Use with chiller water or properly treated and filtered tower or city water.

Check to make sure all piping connections are secure and that all lines are suitable for water or the coolant in the system at the maximum setpoint temperature and cumulative pressure rating of the maximum pump pressure rise plus the cooling water pressure.

Make sure that the cooling source is the appropriate temperature and pressure for your application. In most cases, the cooling source is between 40°F {4°C} and 85°F {29°C}. The minimum cooling source fluid pressure must be at least 30 PSI* in order for the unit to start. The maximum pressure is shown in this chart in order to meet the pressure limitations of standard 150 psi, high-temperature industrial hose/plumbing on the discharge side of the pump.

Pump HP	Max Cooling (PSI)
3/4	95
1	90
2	90
3	85
5	75
7.5	65
10	50

*Adaptive Maximum Setpoint allows for operation below 30 PSI. This feature will automatically adjust maximum temperature setpoint based off of supplied pressure with certain heater and pump combinations.

Typical Applications (Continued)

The limiting factor regarding the maximum cooling pressure is the presumed 150 PSI Rating of industry-standard hose. The hose must be able to withstand the maximum possible process temperature at maximum possible pressure.

Your cooling water pressure may exceed the values shown in the chart ONLY if you are utilizing specialty high-pressure/ high-temperature hose.

All RQT Advanced units have pressure transducers, and the software will limit setpoint depending on average cooling source pressure. The pressure relief valve is located on the “From Process” side of the pump, and will start to discharge if the pressure exceeds 135 psi. If this becomes an issue, install a pressure-regulating valve (available from our Parts Department) on the cooling water supply line to help regulate the pressure to ensure it is well below the pressure rating of the pressure relief valve. For further assistance in installing a pressure-regulating valve, please contact our Customer Service Department.

System Fill Water Chemistry Requirements

The properties of water make it ideal for heat transfer applications. It is safe, non-flammable, non-poisonous, easy to handle, widely available, and inexpensive in most industrialized areas.

When using water as a heat transfer fluid it is important to keep it within certain chemistry limits to avoid unwanted side effects. Water is a “universal solvent” because it can dissolve many solid substances and absorb gases. As a result, water can cause the corrosion of metals used in a cooling system. Additionally, dissolved minerals naturally present in tap water will precipitate out onto the system plumbing at elevated fluid temperatures, forming scale. The life giving properties of water can also encourage biological growth that can foul heat transfer surfaces. *See “Fill Water Chemistry” in the Installation section of this User Guide.*

How the RQT Advanced Direct Injection Works

Direct Injection models maintain the process temperature by electrically heating and/or injecting cool water supplied to the RQT Advanced by a chiller, tower, or other water source.

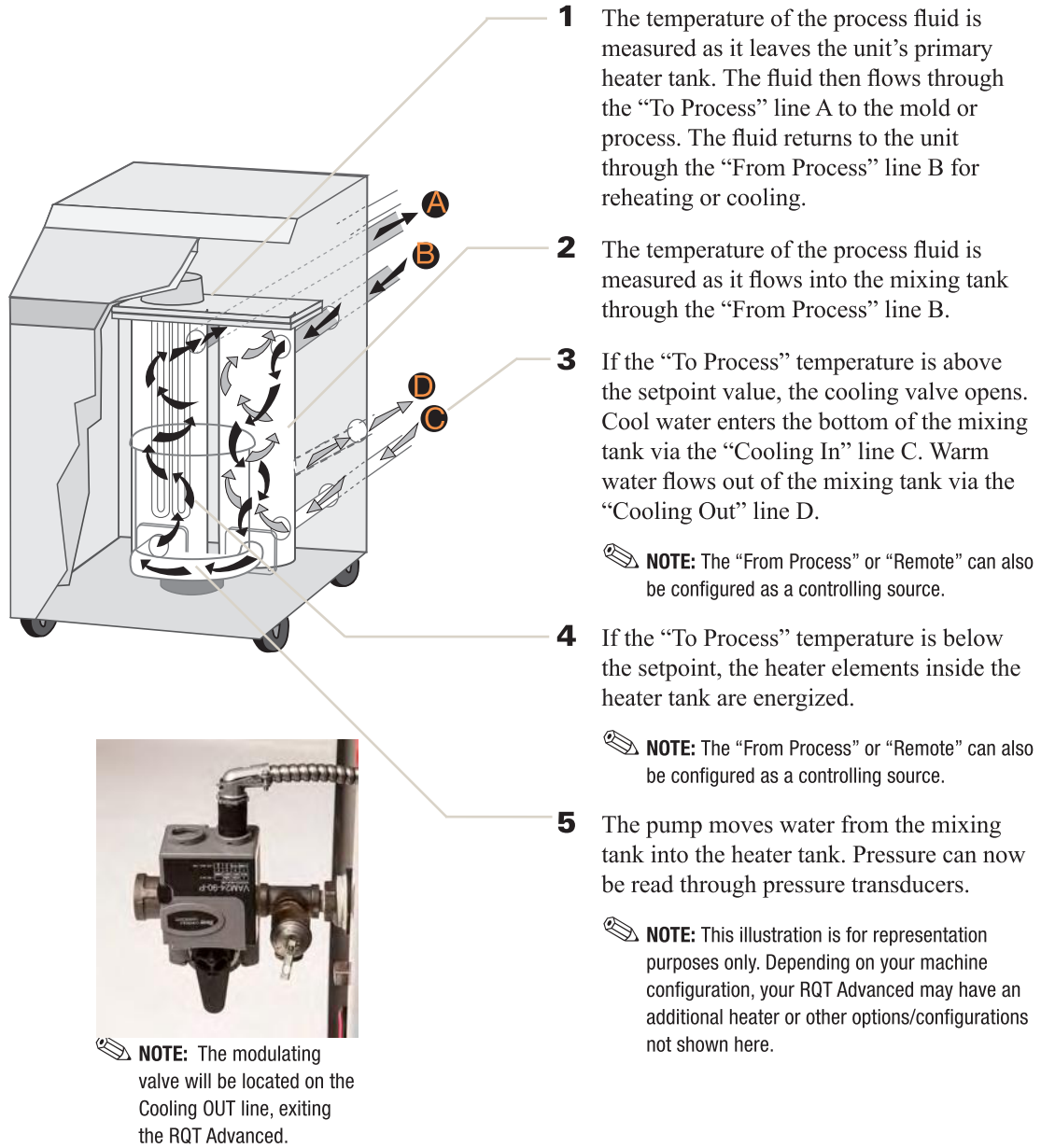

Refer to the Direct Injection Plumbing Diagram for the RQT Advanced in Appendix C of this User Guide.

How the Closed Circuit Common Source Works

Closed Circuit RQT Advanced models maintain the process temperature by electrically heating and indirectly cooling fluid in the process circuit. Cooling water supplied by a chiller, tower or other water source, is mixed with the process fluid only during the initial filling or when water is needed to make up process fluid loss. A brazed-plate heat exchanger replaces the mixing tank used on direct injection units.

- 1** The temperature of the process fluid is measured as it leaves the unit's heater tank. The fluid then flows through the "To Process" line to the mold or process. The fluid returns to the unit through the "From Process" line for reheating or cooling.
 - 2** If the temperature is above the setpoint value, the cooling valve opens. Cool water enters the heat exchanger via the "Cooling In" line. Process fluid is always being circulated through the process side of the heat exchanger. The process fluid is indirectly cooled via conduction from the colder water now running through the cooling side of the heat exchanger. If the measured temperature is below the setpoint, the heater elements inside the heater tank are energized.
-  **NOTE:** The "From Process" or "Remote" can also be configured as a controlling source.
- 3** The pump moves water from the heat exchanger to the heater tank. Pressure is measured before and after the pump with pressure transducers. If the "To Process" temperature is below the setpoint, the heater elements inside the heating tank are energized.



 **NOTE:** The modulating valve will be located on the Cooling OUT line, exiting the RQT Advanced.

Refer to the Closed Circuit Common Source Plumbing Diagram for the RQT Advanced in Appendix C of this User Guide.

RQT Advanced Control Features vs RQT Premium & Standard

Control, RQT Advanced

WATER TEMPERATURE CONTROLLER

Easy Access

Easy access to User Parameters & Settings screens

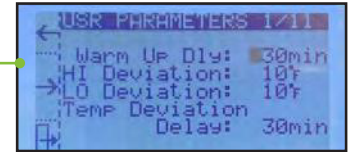

LCD Display

Access features with illuminated control buttons



Simple On/Off Operation

Easily accessible On/Off button



Integrated Diagnostics

Run advanced diagnostics whether the TCU is running or off.

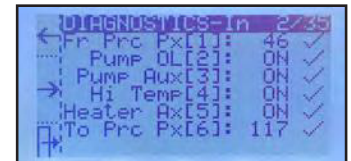

Auto Restart Capability

Control Features on the RQT Advanced

Model	RQT Advanced
Direct Injection	●
Closed Circuit - Common Source	○
Closed Circuit - Separate Source	○
Construction	
Standard Pump Range	3/4 to 10 Hp
Standard Heater Range	0 to 48 kW
Cast Heater / Pump	●
Incoloy Heaters	●
Silicon Carbide Seals	●
Pressure Gauges	●
Pressure Transducer	●
Solid State Heater Relays (SSRS)	○
Controls	
PID Control	●
Setpoint / Actual Display	●
Password Protection	●
Modbus-RTU via RS-485	●
Modbus-TCP via Ethernet	○
SPI RS-485 Interface	○
OPC-UA via Ethernet	○
Retransmit Process Temp (0-10 VDC)	●
Auto Restart Capability	●
Mold Purge (Factory Installed)	○
Phase Detection Circuit	○
Choice of Control Points	●
Auto Cool Stop	●
Status / Alarm Lights	
Audible Alarm	●
Strobe Light	○
Alarm Dry Contacts	○
Remote RTD Support	●
Trending	○

- Standard
- Optional

Purge On/Off button included on control.

Phase detection indicates incorrect pump rotation or an open electrical leg.

Control temperature based on temperature at process supply or return points, or an average of the two points.

Control Features on the RQT Premium and RQT Standard

Model	RQT Premium	RQT Standard
Direct Injection	●	●
Closed Circuit - Common Source	○	○
Closed Circuit - Separate Source	○	○
Construction		
Standard Pump Range	3/4 to 10 Hp	3/4 or 2 Hp
Standard Heater Range	0 to 48 kW	12 kW
Cast Heater / Pump	●	●
Incoloy Heaters	●	●
Silicon Carbide Seals	●	●
Pressure Gauges	●	●
Pressure Transducer	●	●
Solid State Heater Relays (SSRS)	○	○
Controls		
PID Control	●	●
Setpoint / Actual Display	●	●
Password Protection	●	○
Modbus-RTU via RS-485	○	○
Modbus-TCP via Ethernet	●	○
SPI RS-485 Interface	○	○
OPC-UA	●	○
Retransmit Process Temp	●	○
Auto Restart Capability	●	○
Mold Purge (Factory Installed)	○	○
Phase Detection Circuit	●	○
Choice of Control Points	●	●
Auto Cool Stop	●	○
Status / Alarm Lights		
Audible Alarm	●	○
Strobe Light	○	○
Alarm Dry Contacts	○	○
Remote RTD Support	●	○
Trending	●	○

Specifications: RQT Advanced

Models	RQT Advanced (direct injection) [†]	RQT Advanced (optional closed circuit) [§]
Performance characteristics		
Minimum setpoint temperature °F (°C)	40 {4} (with 100% water process fluid), 18 {-8} (with 75% water / 25% glycol mix), -22 {-30} (with 50% water / 50% glycol mix)	
Maximum setpoint temperature °F (°C)	250 {121}, (300 {149} optional ^{††}) ^{§§}	
Minimum operating temperature °F (°C)	Approximately 20° {11°} above the cooling water inlet temperature ^{††}	
Standard cooling valve size inches {mm}	1/2 {12.7} (Cv=2.9) (varies) (other sizes available as optional special order units)	
Available pump sizes	0.75, 1, 2, 3, 5, 7.5, 10 Hp {0.56, 0.75, 1.49, 2.24, 3.73, 5.59, or 7.46 kW} ^{***}	
Available heater sizes	0, 9, 12, 18, 24, 36 or 48 kW	0, 9, 12, 18, 24, or 36 kW
Connections to/from process NPT (female)	1.50 inches	
Connections in/out cooling water NPT (female)	1.00 inches	

Pump performance - Consult your Thermal Care representative for pump performance characteristics at other operating points.

Pump	3/4 Hp {0.56 kW}	1 Hp {0.75 kW}	2 Hp {1.49 kW}	3 Hp {2.24 kW}	5 Hp {3.73 kW}	7.5 Hp {5.59 kW}	10 Hp {7.46 kW}
Nominal flow gpm {lpm}	50 {189}	55 {208}	75 {284}	85 {322}	100 {379}	120 {454}	150 {568}
Pressure @ nominal flow psi {kg/cm ² } ^{††}	20 {1.4}	25 {1.7}	30 {2.1}	32 {2.2}	46 {3.2}	56 {3.9}	65 {4.5}

Dimensions inches (mm) ^{††}				
Cabinet style	Single Zone Small (A)	Single Zone Large (A)	Dual Zone Small (B) [†]	Dual Zone Large (B) [†]
Height	24.98 {634}	28.98 {735}	24.98 {635}	28.98 {736}
Width	14.09 {358}	14.09 {358}	28.41 {722}	28.41 {722}
Depth	24.09 {612}	26.09 {663}	24.09 {612}	26.09 {663}

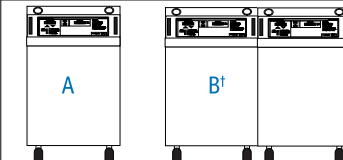

Advanced & Premium Only[†]

Shipping weight ranges lb {kg} Weights vary depending on cabinet size, options, and cooling type (DI or CC).

Pump	Single Zone				Dual Zone			
	Minimum	Maximum	Minimum	Maximum				
0.75 Hp {0.56 kW}	240 {109}	280 {127}	491 {223}	576 {261}				
1 Hp {0.75 kW}	245 {111}	290 {132}	499 {226}	584 {265}				
2 Hp {1.49 kW}	248 {113}	298 {135}	515 {234}	590 {268}				
3 Hp {2.24 kW}	259 {118}	299 {136}	538 {244}	623 {283}				
5 Hp {3.73 kW}	302 {137}	352 {160}	629 {285}	699 {317}				
7.5 Hp {5.59 kW}	317 {144}	362 {164}	649 {294}	729 {331}				
10 Hp {7.46 kW}	329 {149}	379 {172}	683 {310}	763 {346}				

Total full load amps per zone ^{††}

Heater	9 kW				12 kW				18 kW			
	460/3/60	208-230/3/60	575/3/60	400/3/50	460/3/60	208-230/3/60	575/3/60	400/3/50	460/3/60	208-230/3/60	575/3/60	400/3/50
Pump size												
0.75 Hp {0.56 kW}	12.9	25.8	10.4	14.9	16.7	33.3	13.4	19.2	24.2	48.4	19.5	27.9
1.0 Hp {0.75 kW}	13.2	24.3	10.5	16.0	17.0	34.0	13.5	20.3	24.5	49.1	19.6	29.0
2.0 Hp {1.49 kW}	14.4	28.7	11.5	17.1	18.2	36.2	14.5	21.4	25.7	51.3	20.6	30.1
3.0 Hp {2.24 kW}	15.5	31.5	12.4	18.1	19.3	39.0	15.4	22.4	26.8	54.1	21.5	31.1
5.0 Hp {3.73 kW}	17.6	36.1	14.0	18.7	21.4	43.6	17.0	22.5	28.9	58.7	23.1	30.0
7.5 Hp {5.59 kW}	20.2	41.1	15.9	23.2	24.0	48.6	18.9	27.0	31.5	63.7	25.0	34.5
10.0 Hp {7.46 kW}	23.6	N/A	18.8	N/A	27.4	N/A	21.8	N/A	34.9	N/A	27.9	N/A

Total full load amps per zone [§]

Heater	24 kW				36 kW				48 kW			
	460/3/60	208-230/3/60	575/3/60	400/3/50	460/3/60	208-230/3/60	575/3/60	400/3/50	460/3/60	208-230/3/60	575/3/60	400/3/50
Pump size												
0.75 Hp {0.56 kW}	31.7	63.4	25.5	36.5	46.8	N/A	37.5	N/A	61.8	N/A	49.6	N/A
1.0 Hp {0.75 kW}	32.0	64.1	25.6	37.6	47.1	N/A	37.6	N/A	62.1	N/A	49.7	N/A
2.0 Hp {1.49 kW}	33.2	66.3	26.6	38.7	48.3	N/A	38.6	N/A	63.3	N/A	50.7	N/A
3.0 Hp {2.24 kW}	34.3	69.1	27.5	39.7	49.4	N/A	39.5	N/A	64.4	N/A	51.6	N/A
5.0 Hp {3.73 kW}	36.4	73.7	29.1	37.5	51.5	N/A	41.1	N/A	66.5	N/A	53.2	N/A
7.5 Hp {5.59 kW}	39.0	78.7	31.0	42.0	54.1	N/A	43.0	N/A	69.1	N/A	55.1	N/A
10.0 Hp {7.46 kW}	42.4	N/A	33.9	N/A	57.5	N/A	45.9	N/A	72.5	N/A	58.0	N/A

Specification Notes

- * Lower operating temperatures can be obtained with larger cooling valves.
 - † Available in RQT Advanced and RQT Premium models only.
 - † Direct Inject (DI) cooling injects cooling water directly into the process loop upon demand.
 - § Closed Circuit Common Source (CCCS) cooling injects cooling water in the process loop only during the initial filling or when make-up water is needed. Closed Circuit Separate Source maintains separation via heat exchanger between the cooling and process fluids at all times.
 - ** FLA data for reference purposes only. Does not include any options/accessories on equipment. For full FLA detail of specific machines/systems, refer to the electrical diagrams of the equipment order and the nameplate applied.
 - †† 300°F units require 75 psi minimum inlet cooling source pressure to operate at the highest temperature at sea level. Higher elevations will require slightly more pressure.
 - †† Smaller frame only available on 3/4HP-3HP units with 0-18kW Heater option, without UL508A option.
 - §§ With sufficient cooling water pressure
 - *** 10 HP not available for 50Hz
- Specifications may change without notice. Consult with the manufacturer for the most current information.

Page intentionally left blank.

Installation

Unpacking the Boxes 3-2

Preparing for Installation 3-3

Fluid Distribution Piping 3-6

Installation - Electrical 3-7

Connecting Process and Water Supply Lines
Without Purge..... 3-8

Connecting Process and Water Supply Lines
With Optional Mold Purge Valve Connections.... 3-9

Connecting the Main Power Source3-10

Testing the Installation.....3-11

Initial Setup3-12

Setpoint3-14

Setting Process Value Source.....3-14

Setting Up Your Controller3-15

Unpacking the Boxes

RQT Advanced models come fully assembled. If it was specified at the time of the order, the optional purge valve is factory-installed.



CAUTION: Lifting

To avoid personal injury or damage to the RQT Advanced, lift the unit using a forklift or hoist with straps that have been positioned at the center of gravity. If using straps, be sure to use a spreader bar or equivalent so the top sheet metal of the unit isn't inadvertently pinched due to the lifting action.



- 1 Carefully remove the RQT Advanced** and components from their shipping containers.
- 2 Remove all packing material**, protective paper, tape and plastic. Compare contents to the shipping papers to ensure that you have all the parts.
- 3 Carefully inspect all components** to make sure no damage occurred during shipping. Check all wire terminal connections, bolts, and any other electrical connections, which may have loosened during shipping.
- 4 Record serial numbers and specifications** in the blanks provided on the back of the User Guide's title page. This information will be helpful if you ever need service or parts.
- 5 You are now ready to begin installation.** *See Installation Section entitled, Preparing for Installation.*



NOTE: If the temperature control unit is stored prior to installation, it is important to protect it from damage. Blow out any water from the unit to protect it from damage from freezing. Cover the equipment to keep dirt and debris from accumulating on it. Units should not be stored in areas warmer than 145°F {63°C}.

Preparing for Installation

The RQT Advanced is easy to install, if you plan the location and prepare the area properly.

⚠ WARNING: Improper installation, operation, or servicing may result in equipment damage or personal injury.

This equipment should only be installed, adjusted, and serviced by qualified technical personnel who are familiar with the construction, operation, and potential hazards of this type of machine.

All wiring, disconnects, and fuses should be installed by qualified electrical technicians in accordance with electrical codes in your region. Always maintain a safe ground. Do not operate the equipment at power levels other than what is specified on the machine serial tag and data plate.

1 Position the RQT Advanced as close to the process machine as possible.

2 Make sure the installation area provides:

- A three-phase power source supplying the correct current for your RQT Advanced model.** Check the serial tag on the unit for required voltage, phase, frequency, and full load amps. Check the electrical power prints for the disconnect fuse size and minimum wire connection size. All wiring should be completed by qualified personnel and should comply with your region's electrical codes.
- Compressed, dry air (<100 psi)** if your RQT Advanced is equipped with the Mold Purge option.
- A clean, well-ventilated environment.** The room temperature should not exceed 104°F {40°C} with 95% non-condensing humidity and should not fall below 32° F {0° C}.
- Minimum clearance for safe operation and maintenance.** The diagram at the right shows minimum clearance for operation. You also need enough clearance in rear for water hookups. For maintenance, you should move the RQT Advanced to provide at least 36 inches {91 cm} on any side of the RQT Advanced. Additionally, your required electrical codes may require a larger service area in front of the electrical panel.

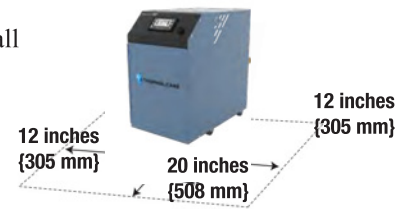
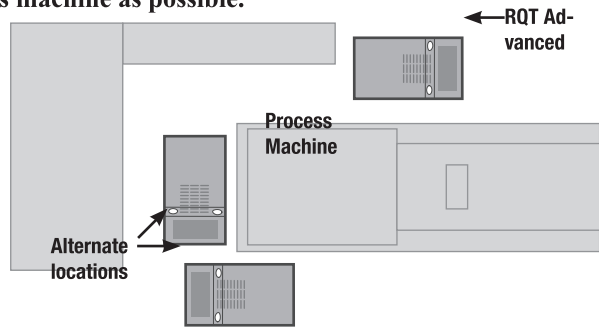

📎 NOTE: For units with pressure transducers, the TCU will operate with incoming water below the 30 PSI minimum, but will automatically adjust the maximum temperature setpoint based off of the incoming supply water pressure.

Preparing for Installation (Continued)

Pump HP	Max Cooling (PSI)
3/4	95
1	90
2	90
3	85
5	75
7.5	65
10	50

(Assumes process hoses and process plumbing is rated to 150 psi.)

 **NOTE:** If your cooling water pressure exceeds the cooling water pressure chart referenced previously, install a pressure-regulating valve before the cooling inlet.

- A source of water for cooling.** City, tower or chiller water may be used, as long as the supply pressure is at least 30 PSI*. Refer to max cooling water pressure chart shown to the left.
- Check to make sure all piping connections are secure** and that all lines are suitable for water or the coolant in the system at the maximum setpoint temperature and cumulative pressure rating of the maximum pump pressure plus the cooling water supply pressure, or the nameplate rating of the pressure relief valve, whichever is greater.
- A location to mount an external three-phase, fused, and grounded electrical disconnect.**
- Lockable isolation devices for all utilities,** including electrical disconnect, cooling water line valves, and compressed air supply disconnect and bleed-off.

*Dynamic Max Setpoint allows for operation significantly below 30 PSI with certain combinations of pump HP and heater kW. This feature will automatically adjust maximum temperature setpoint based off of supplied pressure.
- Make sure that the cooling source is the appropriate temperature and pressure for your application.** In most cases, the cooling source is between 40°F {4°C} and 85°F {29°C}. For most applications, the design cooling source supply pressure is between 30 psi and 50 psi. Units with the 300°F operating range option require an inlet cooling source pressure of at least 75 psi (at sea level), in order to be permitted to operate the unit all the way up to 300°F. The pressure relief valve is located on the “From Process” side of the pump, and will start to discharge if the pressure exceeds 135 psi. If this becomes an issue, install a pressure-regulating valve (available from our Parts Department) on the supply line to help regulate the pressure to ensure it does not exceed the pressure rating of the pressure relief valve. For further assistance in installing a pressure-regulating valve, please contact our Customer Service Department.

System Fill Water Chemistry Requirements

The properties of water make it ideal for heat transfer applications. It is safe, non-flammable, non-poisonous, easy to handle, widely available, and inexpensive in most industrialized areas.

When using water as a heat transfer fluid it is important to keep it within certain chemistry limits to avoid unwanted side effects. Water is a “universal solvent” because it can dissolve many solid substances and absorb gases. As a result, water can cause the corrosion of metals used in a cooling system. Additionally, dissolved minerals naturally present in tap water will precipitate out onto the system plumbing at elevated fluid temperatures, forming scale. The life giving properties of water can also encourage biological growth that can foul heat transfer surfaces.

Preparing for Installation (Continued)

To avoid the unwanted side effects associated with water cooling, proper chemical treatment and preventive maintenance is required for continuous plant productivity.

Unwanted Side Effects of Improper Water Quality

- Corrosion
- Scale
- Fouling
- Biological Contamination

Cooling Water Chemistry Properties

- Electrical Conductivity
- pH
- Alkalinity
- Total Hardness
- Dissolved gases

The complex nature of water chemistry requires a specialist to evaluate and implement appropriate sensing, measurement and treatment needed for satisfactory performance and life. The recommendations of the specialist may include filtration, monitoring, treatment and control devices. With the ever-changing regulations on water usage and treatment chemicals, the information is usually up-to-date when a specialist in the industry is involved. The table below shows the list of water characteristics and quality limitations.

Fill Water Chemistry Requirements

Water Characteristic	Quality Limitation
Alkalinity (HCO ₃ ⁻)	70-300 ppm
Aluminum (Al)	Less than 0.2 ppm
Ammonium (NH ₄)	Less than 2 ppm
Chlorides (Cl)	Less than 300 ppm
Electrical Conductivity	10-500µS/cm
Free (aggressive) Carbon Dioxide (CO ₂) [†]	Less than 5 ppm
Free Chlorine(Cl ₂)	Less than 1 PPM
HCO ₃ ⁻ /SO ₄ ²⁻	Greater than 1.0
Hydrogen Sulfide (H ₂ S)	Less than 0.05 ppm
Iron (Fe)	Less than 0.2 ppm
Manganese (Mn)	Less than 0.1 ppm
Nitrate (NO ₃)	Less than 100 ppm
pH	7.5-9.0
Sulfate (SO ₄ ²⁻)	Less than 70 ppm
Total Hardness (dH)k	4.0-8.5

[†] Dissolved carbon dioxide calculation is from the pH and total alkalinity values shown below or measured on the site using a test kit. Dissolved Carbon Dioxide, PPM = TA x 2^[(6.3-pH)/0.3] where TA = Total Alkalinity, PPM as CaCO₃

Preparing for Installation (Continued)

Recommend Glycol Solutions

Chilled Water Temperature	Percent Glycol By Volume
50°F (10°C)	Not required
45°F (7.2°C)	5 %
40°F (4.4°C)	10 %
35°F (1.7°C)	15 %
30°F (-1.1°C)	20 %
25°F (-3.9°C)	25 %
20°F (-6.7°C)	30 %



CAUTION: When your application requires the use of glycol, use industrial grade glycol specifically designed for heat transfer systems and equipment. Never use glycol designed for automotive applications. Automotive glycols typically have additives engineered to benefit the materials and conditions found in an automotive engine; however, these additives can gel and foul heat exchange surfaces and result in loss of performance or even failure of the chiller. In addition, these additives can react with the materials of the pump shaft seals resulting in leaks or premature pump failures.



WARNING: Ethylene Glycol is flammable at higher temperatures in a vapor state. Carefully handle this material and keep away from open flames or other possible ignition sources.



3 Install plumbing for process and cooling lines.

You will need two 1½-inch NPT male fittings for the process inlet and outlet and two 1-inch NPT male fittings for the cooling inlet and outlet. Larger line sizes are acceptable as long as they are reduced at the RQT Advanced connections. Smaller line sizes are not recommended.

Contact IMS Company for more information about recommendations for your product.

Fluid Distribution Piping

Proper insulation of any cooling fluid system where the supply cooling fluid temperature is below the dew point is crucial to prevent condensation. In most cases this will apply to systems where the supply temperature is 55°F {13°C} or colder. The formation of condensation on water piping caused by the state change of the water from gas to liquid adds a substantial heat load and becomes an additional burden for the cooling system.

The importance of properly sized piping between the cooling system and the temperature control unit and between the temperature control unit and the process cannot be over-emphasized. See the ASHRAE Handbook or other suitable design guide for proper pipe sizing. In general, run full size piping out to the process and then reduce the pipe size to match the connections on the process equipment. One of the most common causes of unsatisfactory unit performance is poor piping system design. Avoid long lengths of hoses, quick disconnect fittings, and manifolds wherever possible as they offer high resistance to water flow. When manifolds are required, install them as close to the use point as possible. Provide flow-balancing valves at each machine to assure adequate water distribution in the entire system. We recommend shut-off valves at each machine to allow for isolation of the unit.

Installation - Electrical

As you prepare to power-up your RQT Advanced, there are a few steps you should take to ensure it will be compatible with your facility's electrical power.

- All wiring must comply with local codes and the National Electric Code (NEC). Full Load Amperes (FLA) and other unit electrical data are on the unit nameplate.
- A unit specific electrical schematic ships with the unit. This contains details about suggested upstream disconnect and wiring sizing, both of which your electrician will find useful.
- A qualified individual should measure each leg of the main power supply voltage at the main power source. Voltage must be within the voltage utilization range given on the drawings included with the unit. If the measured voltage on any leg is not within the specified range, notify the supplier and correct before operating the unit.
- Voltage imbalance must not exceed two percent. Excessive voltage imbalance between the phases of a three-phase system can cause motors to overheat and eventually fail. Voltage-imbalance is determined using the following calculations:

$$\% \text{Imbalance} = (V_{\text{avg}} - V_x) \times 100 / V_{\text{avg}}$$

$$V_{\text{avg}} = (V1 + V2 + V3) / 3$$

$$V_x = \text{phase with greatest difference from } V_{\text{avg}}$$

For example, if the three measured voltages were 442, 460, and 454 volts, the average would be:

$$(442 + 460 + 454) / 3 = 452$$

The percentage of imbalance is then:

$$(452 - 442) \times 100 / 452 = 2.2 \%$$

This exceeds the maximum allowable of 2%.

- There is a terminal block for main power connection to the main power source. The main power source should be connected to the terminal block through an appropriate disconnect switch. There is a separate lug in the main control panel for grounding the unit.
- Check the electrical phase sequence at installation and prior to start-up. Operation of the unit with incorrect electrical phase sequencing will result in improper pump performance or unit damage.
- Check the phasing with a phase sequence meter prior to applying power. The proper sequence should read "clockwise" or "ABC" or "L1, L2, L3" on the meter. If the meter reads "counter-clockwise" or "CBA" or "L3, L2, L1", disconnect and lockout main electrical power and switch two line leads on the line power terminal blocks (or the unit mounted disconnect). Do not interchange any load leads that are from the unit contactors or the motor terminals.

Connecting Process and Water Supply Lines Without Purge

Tools for Installation:

- Pipe wrench large enough for a 2-inch pipe
- Premium quality Teflon thread sealant

 **NOTE: IMS Company** recommends using a second wrench, sometimes referred to as a “back-up wrench”, to support the piping when making connections to the RQT Advanced.

 **NOTE: IMS Company** recommends that you install an external ball valve on the cooling water inlet of the RQT Advanced. This valve is required when the purge valve option is installed. [See plumbing diagram in Appendix C.](#)

The RQT Advanced process inlets and outlets must be connected to the plumbing that will circulate the temperature-controlled water or fluid through the process. Cooling water inlets and outlets are connected to the cooling water supply.

- 1 Remove the shipping pipe plug** from the female connections on the back of the RQT Advanced.
- 2 Install pipe to the rear of the RQT Advanced.** Use male 1½-inch NPT piping for process connections and male 1-inch NPT piping for water connections. Pipe and pipe threads must be clean and new. Clean threads with solvent, removing all oil, grease and dirt. Allow the threads to dry before proceeding.
- 3 Coat the pipe threads with thread sealant.** Follow the sealant manufacturer’s directions.
- 4 Connect the male pipe to the appropriate female connection** on the back of the unit. Start by hand until the threads engage, then use a pipe wrench to tighten the connection only enough to prevent leaks. **Do not over-tighten!**

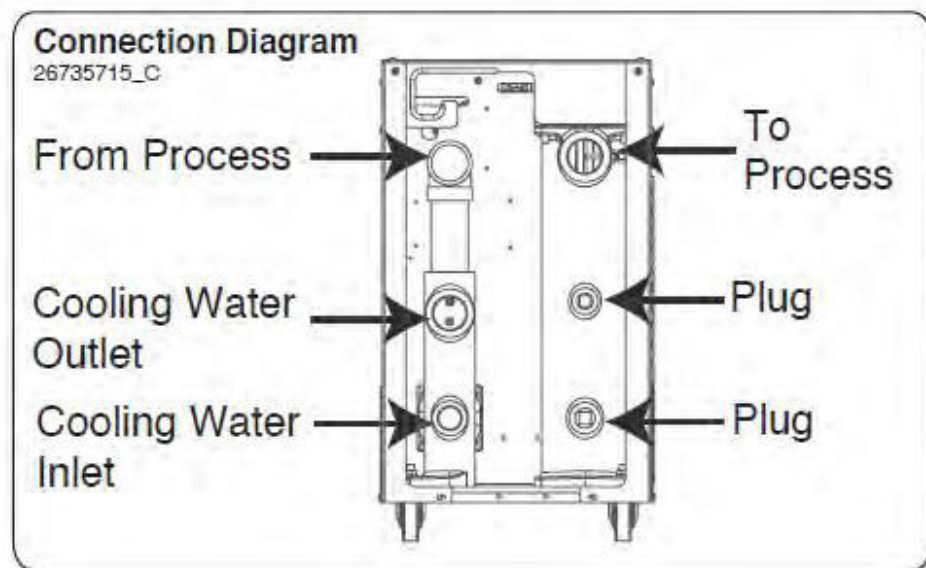

Sample Connection Diagram

Always refer to the connection diagram sticker on the back of your machine for proper connection locations.

IMPORTANT: Be aware that room-temperature water frequently contains a surprisingly large quantity of dissolved air within it, and this air will separate from the water once heated to an elevated temperature. Additional provisions may have to be made to remove this air from the fluid loop, as it will inhibit heat transfer, and damage the pump and heater if it comes out of solution.

Connecting Process and Water Supply Lines With Optional Mold Purge Valve Connections

A mold purge valve is available as an option. This valve quickly evacuates fluid from the process circuit, allowing faster disconnection of the temperature controller from molds and hoses.

TIP: IMS Company recommends ordering the purge valve with the RQT Advanced so that wiring and installation is completed at the factory. However, aftermarket addition of the purge valve is possible. To order contact Parts at Phone: 847-966-8560

If this option is ordered with the RQT Advanced, purge control wiring and installation of the valve on the process line outlet of the unit is completed at the factory. You still must connect process and cooling water inlets and outlets, as well as supply non-lubricated compressed air.

- 1 Remove the shipping pipe plug** from the female connections on the back of the RQT Advanced.
- 2 Install an external ball valve on the cooling water inlet of the RQT Advanced.** This valve is required when a purge valve is used.
- 3 Install pipe to the rear of the RQT Advanced.** Use male 1½-inch NPT piping for process connections and male 1-inch NPT piping for water connections. Pipe and pipe threads must be clean and new. Clean threads with solvent, removing all oil, grease and dirt. Allow the threads to dry before proceeding.
- 4 Coat the pipe threads with thread sealant.** Follow the sealant manufacturer’s directions.
- 5 Connect the male pipe to the appropriate female connection** on the back of the unit. Connect cooling water lines as indicated on the previous page. Connect process lines as indicated below. Start by hand until the threads engage, then use a pipe wrench to tighten the connection only enough to prevent leaks. **Do not over-tighten!**
- 6 Connect the purge valve to the compressed air supply.** The air pressure should not exceed 100 psi. It is strongly recommended a lockable air valve be installed in order to effectively lockout this energy source when performing equipment maintenance.

 **NOTE:** For information about how to add a purge valve to your RQT Advanced if you did not order it equipped that way from the factory, contact Customer Service.

 **NOTE:** See “Using the Mold Purge Option” in the Operation section of this User Manual.

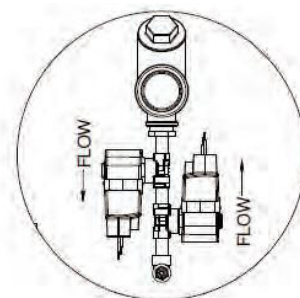

Sample Graphic
This illustration may not reflect your configuration.

Connecting the Main Power Source

Tools Required

- Flashlight
- 1/8" Allen Key
- Medium straight-blade screwdriver
- Phase rotation meter

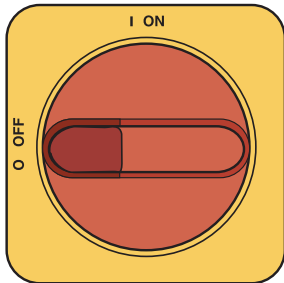

Optional Disconnect Switch

IMPORTANT: Always refer to the wiring diagrams that came with your temperature control unit before making electrical connections. The diagrams show the minimum size main power cable required for your unit, and the most accurate electrical component information.

IMPORTANT: Before initiating power to the unit:

- Check the system for leaks.
- Verify that the voltage, phase, frequency, amperage, disconnect fuse, and minimum wire size meet the specifications.
- Verify that resistance to ground on each phase is at least 1 mega ohm (use a multi-meter, not a megger for this measurement).

Before beginning, note the electrical specifications on the serial tag mounted to the side of the unit. The electrical connection must match these specifications with +/- 10% (+/- 15% for 400 V/50 Hz) maximum voltage variance and <2% imbalance. An improper power supply could damage the unit as well as seriously injure an operator. The electrical connection should run through a fused disconnect sized for the amperage noted on the electrical prints and conforming to all local and national codes, including Article 250 of the National Electric Code.



WARNING: Electrical Hazard



Before performing maintenance or repairs on this product, disconnect and lock out electrical power sources to prevent injury from unexpected energization or start-up. A lockable device must be used to isolate this product from potentially hazardous electricity.



WARNING: Improper installation, operation, or servicing may result in equipment damage or personal injury.



This equipment should only be installed, adjusted, and serviced by qualified technical personnel who are familiar with the construction, operation, and potential hazards of this type of machine.

All wiring, disconnects, and fuses should be installed by qualified electrical technicians in accordance with electrical codes in your region. Always maintain a safe ground. Do not operate the equipment at power levels other than what is specified on the machine serial tag and data plate.

- 1 Open the unit's electrical enclosure.** Removing the top panel using a 1/8" Allen key is required. The RQT Advanced comes from the factory with a knockout for 1/2 inch conduit. A knockout punch should be used if necessary to enlarge the hole for larger diameter conduits.



- 2 Install electrical conduit as desired, along with main power wires inside the conduit, or install the cord.** See electrical prints for recommended wire size. Knock out on the upper left hand side of the back of the electrical panel.

 **NOTE:** If using a flexible cord, secure the wire with a rubber compression fitting or strain relief.

- 3 Connect the power wires to the terminals indicated on the wiring diagram** that came with your machine. The RQT Advanced comes pre-wired expecting clockwise (L1-L2-L3) phase rotation. Use a phase rotation meter to verify correct phasing. [See "Installation - Electrical" in this section of the User Guide for more information.](#)

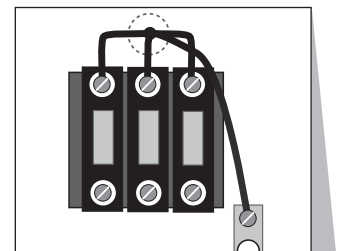

- 4 Check every terminal screw to make sure wires are secure.** Gently tug each wire. If a wire is loose, use a screwdriver or allen wrench to tighten the terminal.

- 5 Connect the ground wire to the grounding lug** shown in the wiring diagram shipped with your unit.

- 6 Use the "J-Hook" at the back of the top panel** to keep the power away from hot internal components.

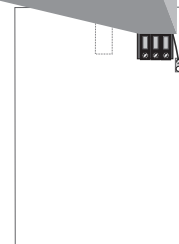

Testing the Installation

 **WARNING: Only qualified personnel should perform this procedure.**

 Part of this test requires opening the unit while it is energized. Only qualified personnel who have been trained in the use of electrical testing devices and in avoiding the safety hazards involved in safely troubleshooting this type of equipment should perform this test procedure.

- 1 Turn on the cooling water supply and check for leaks and proper water cooling pressure.** If any leaks appear, stop the test and fix the problem before continuing. The cooling water must be at least 10-30 psi (depending on your kW/HP configuration), or the unit will not function on standard 250°F {121°C} units less than 48kW. The Adaptive Max Setpoint feature will allow the unit to automatically adjust the maximum temperature setpoint based off of the supplied cooling water pressure.
- 2 Apply power to the unit.** The temperature controller display illuminates to indicate that the control has power. “Loading...” will be displayed for a few seconds while the control boots up. The control then displays the software version, followed by traditional temperature display on the screen.

“Low Process Inlet Pres” will be displayed if low water pressure is present.

3 Set the setpoint to 40°F.

Press the **RUN** button, and wait until the pump starts. It will take approximately 94 seconds to complete vent cycle.

Press the RUN button.

If everything is working correctly:

- The venting and/or pump status bar will pop up on the top of the controller.
- The unit initiates a 64-second venting sequence followed by 30 seconds of venting while the pump runs. The pump starts automatically when the venting sequence is partly complete.
- Normal operation begins. The heater turns on if the process temperature is below setpoint. The cooling valve is activated if the process temperature is above setpoint.



 **NOTE:** If the low pressure warning pops up, verify that the cooling water supplied is connected properly and at the minimum required pressure.

If everything tested correctly, proceed to the Initial Setup instructions on the next page. If something did not work correctly, *refer to the Troubleshooting section of this User Guide.*

 **NOTE:** Pump motor rotation can be viewed at either the back of the motor, or at the exposed shaft where the motor meets the pump.

Tools Required

- Flashlight
- 1/8" Allen Key

Initial Setup

- Operating Mode
- Temperature Units
- Setpoint
- Alarm Points





CAUTION: The RQT Advanced will not operate correctly if certain factory-set parameters are changed. Parameters should only be changed by qualified technical personnel who are familiar with the operation of this type of equipment. If the RQT Advanced does not appear to be working correctly, verify the parameters against the list of factory settings.

For a complete list of the factory-set parameters *see Default Parameters in the appendix of this User Guide.*

Upon initial boot-up, you will be greeted with a load screen that indicates the TCU tier, Hardware (HW), Firmware (FW), Operating System (OS), and Software versions.

Soft Buttons:

Buttons , , and  are considered “soft” buttons. Their function is variable and is dictated by what is shown next then on the screen.



 **NOTE:** The buttons for the LCD Screen are present to the left and right of the screen.

The main menu/settings page can be accessed by tapping on the button corresponding to the wrench icon, shown below.



NOTE: Certain machine configuration details/parameters can only be changed by manufacturer.

Initial Setup (Continued)

Temperature Units

To select the desired temperature units for your system (°F vs. °C), follow this procedure:

- 1** Access the settings window by tapping on the warning symbol corresponding to the wrench icon.



- 2** Use the buttons corresponding to the left and right arrows to access user parameter screen 3 of 11.

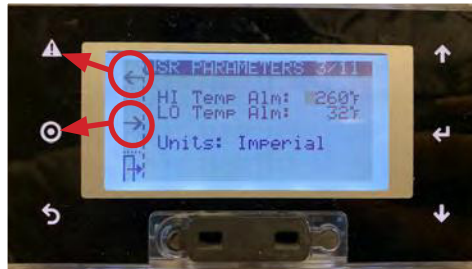

- 3** Once on the user parameter screen use the "Enter" key (shown to the right) to confirm the "HI Temp Alm" and "LO Temp Alm" values in order to reach the units menu item. Use the up and down arrows to the right of the LCD screen to select desired temperature units.

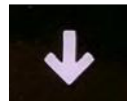

Setpoint

To select the proper setpoint of the system, follow this procedure:

- 1 The temperature setpoint can be quickly adjusted by tapping on the Up and Down arrows on the right of the screen when on the main page.**



NOTE: From the factory the TCU will control the “To Process” or “Supply” fluid to the setpoint. However, this can be modified by following the procedure “Setting Process Value Source” below. Additionally, if further information regarding To, From, remote, or analog temperature information is desired, simply press the Enter key to the right of the screen while on the main page to cycle through the different process source temperature values.

Setting Process Value Source

The TCU can control temperature based off of several other parameters such as Remote RTD, From Process, and Average Process Temperature.

- 1 Access the user parameters screen** by tapping on the button corresponding to the wrench icon on the upper left hand corner.
- 2 Scroll over to the 4th user parameter window screen** by using the buttons corresponding to the left and right arrow keys on screen.
- 3 Once on the 4th screen, use the up and down arrows to cycle through the PV (Process Value) source to the desired setting.** By default, the factory setting is set to monitor and control the process on the “To Process” side.
- 4 In order to determine which process value source the TCU is using, follow the instructions above to access the 4th user parameter window screen.** The PV Source (Process Value) selection will show which process value is currently active.



Setting Up Your Controller

Alarm Points

To select the desired alarm points for your system (low alarm and high alarm), follow this procedure:

1 Stop the RQT Advanced by going to the Home screen and pressing the button corresponding to the OFF icon.

2 Enter the Alarms settings by following the screens below.

3 Ensure that the unit is stopped by checking the banner status on the top of the screen. Once stopped, tap on the button corresponding the wrench icon to access the settings/user parameters window.



4 The first user parameter screen shows HI and LO temperature deviation.

You may select how you want the TCU to act if the temperature deviates from the set temperature.

The high deviation limit, indicates temperature deviation ABOVE the setpoint, whereas the low deviation limit indicates temperature deviation BELOW the setpoint.



5 The second user parameter screen shows HI and LO flow deviation.

You may select how you want the TCU to act if the flow deviates from the expected flow value.

The high deviation limit, indicates flow deviation ABOVE the expected flow value, whereas the low deviation limit indicates flow deviation BELOW the expected flow value.



6 Factory default setting shown. High and low temp alarm settings can be accessed on screen 3.



(Continued)

Setting Up Your Controller (Continued)

User Parameters



Tapping on the button corresponding to the wrench icon will open the User Parameters window screen. This is the start of the parameters screen where the user settings and alarms can be customized.

User Parameters Window Screen 1



Hi/Lo Temperature deviation parameters can be adjusted here.

Warm Up Dly - How much runtime must accumulate after a startup before temperature deviation is sensed.

Temp Deviation Delay - How long the temperature must continuously deviate before setting an alarm warning.

User Parameters Window Screen 2



Hi/Lo Flow deviation parameters can be adjusted here.

Setpoint - The desired flow setpoint

HI Flow Dev - Flow above the setpoint that will produce high flow deviation warning /alarm.

Lo flow Dev - flow below the setpoint that will produce low flow deviation warning/alarm.

Flow Deviation Delay - How long the flow must continuously deviate before setting an alarm or warning.

User Parameters Window Screen 3



Hi/Lo Temperature Alarm parameters can be adjusted here.

Units of measure can also be selected from Imperial or Metric.

 **NOTE:** Changing units will cause unit to reboot.

Setting Up Your Controller (Continued)

User Parameters Window Screen 4

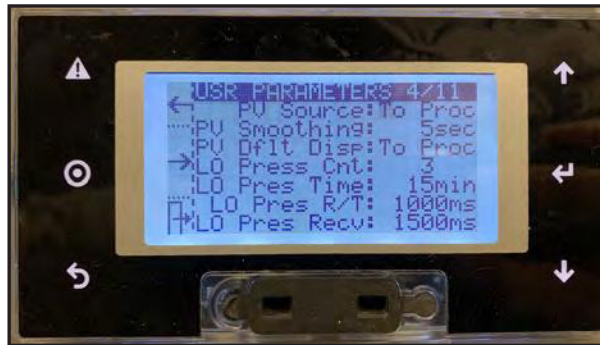

Process Value can be defined here as well as the default display temperature.

PV Source is the temperature value that will be regulated to the setpoint.

PV DfH drop is the default temperature value shown on the screen. They are typically identical, but can be selected differently if desired.

PV Smoothing - How much to average the process value.

User Parameters Window Screen 5

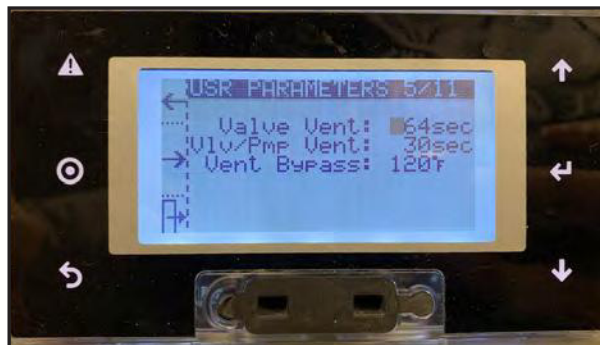

Valve Vent - Initial Vent cycle where the cooling valve opens to allow water to flow through unit.

Valve/Pump Vent: Pump initiates to further facilitate the vent cycle process.

Vent Bypass: Temperature at which if the unit senses that process fluid is at or above set temperature, the TCU will bypass the vent cycle.

User Parameters Window Screen 6



When **Auto Cool Stop** is activated, these are the parameters that dictate how long and what setpoint temperature, it achieves.

Hot Pre Relf - Hot Pressure Relief is a feature primarily used for systems with a check valve installed, that monitors pressure rise in the system and relieves pressure through the cooling valve to prevent pressure relief valve discharge.

I-Active Band - Part of PID parameters, [See Appendix B "PID Parameters" for details.](#)

User Parameters Window Screen 7



PID settings can be adjusted below in order to define how the TCU reacts to temperature changes.

[See Appendix B "PID Parameters" for details.](#)

Lo Press Cnt- Number of times low pressure can occur within Lo Press Time before triggering a shutdown alarm.

Press R/T - Duration of time to ignore a low pressure signal.

Press Recv - Duration of time to wait before automatically restarting once sufficient system pressure return.

Setting Up Your Controller (Continued)

User Parameters Window Screen 8



Warning/Alarm Settings on how the unit will react if set values deviate.

Diagnostics - Diagnostics window showing logs can be accessed here.

Load Defaults - Default settings can be loaded here.

Factory Menu - Factory menu used by manufacturer and service tech personnel.

User Parameters Window Screen 9



SP Source - Setpoint Source: defines which temperature setpoint to use for temperature regulation.

Dyn Max SP - Dynamic Max Setpoint Alarm settings listed show how the unit will react if setpoint exceeds to allowable temperature rating for the pressure supplied when running and stopped. Default is set to Warning.

User Parameters Window Screen 10

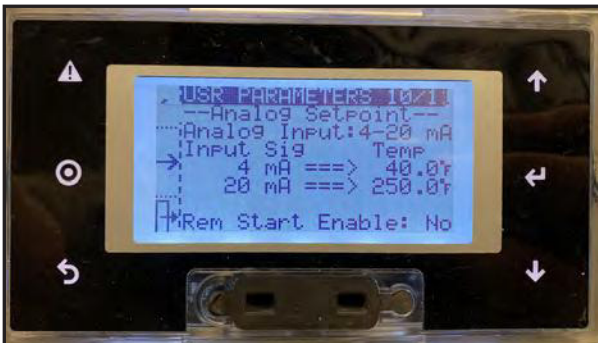

Analog Input used for setting up a remote analog setpoint, which will be utilized if chosen by “SP Source”.

Rem Start Enable - Menu item to enable remote start.

User Parameters Window Screen 11

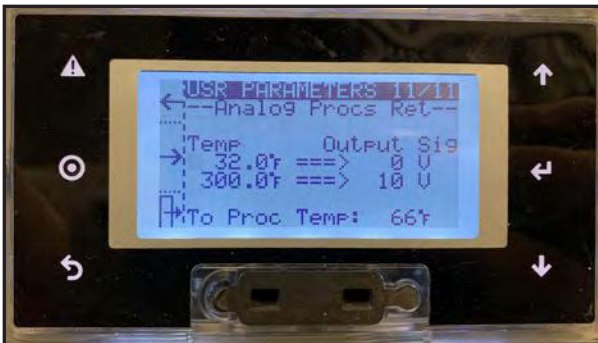

Analog Process Retransmit configures an analog signal that is sent to a remote system which reflects the local “To Process” fluid temperature.

Setting Up Your Controller (Continued)

 **NOTE:** These screens are for diagnostic/display purposes only. They can be helpful to monitor RQT Advanced performance and for troubleshooting any issues.

Diagnostics

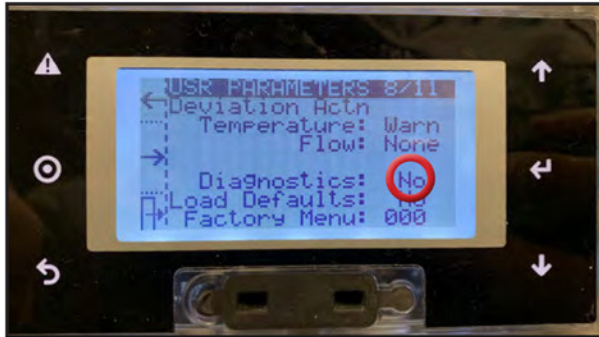

The Diagnostics Menu screen can be accessed in the **User Parameters window screen 8** or by using the **corresponding button next to DGS** when the unit is running.

Diagnostics window displays data relating to alarms, pump/heater run times, current pressure/temperature of the unit, as well as input/output hardware values.

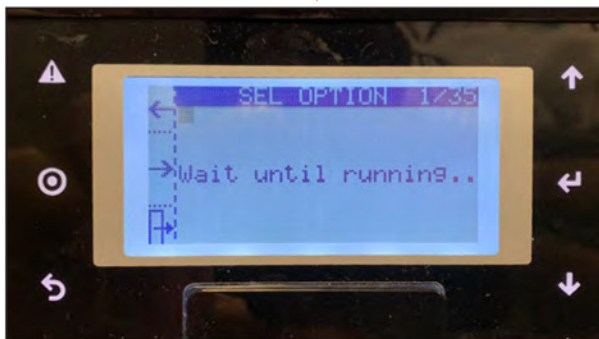

Diagnostics window when TCU is OFF and accessed through the user parameters window. Use the corresponding buttons for left and right to navigate to the next diagnostics screen.

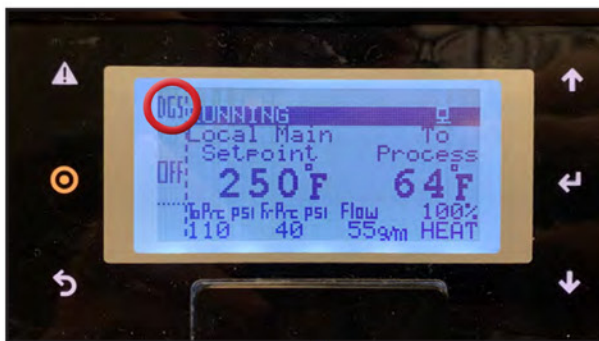

Location of the button next to DGS when the unit is running.



Auto Cool Stop feature can be turned on/off here.

Setting Up Your Controller (Continued)

Diagnostics Screen 2

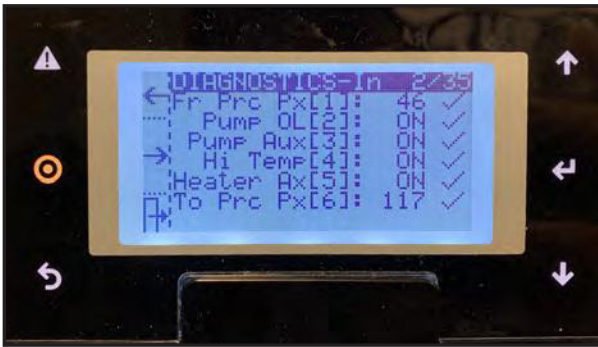

- Checks for the following hardware inputs:**
- From Process Pressure (always displayed in psi)
 - Pump Overload
 - Pump Contactor Auxilliary
 - Hi Temp
 - Heater Contactor Auxilliary
 - To Process Pressure (always displayed in psi)

Diagnostics Screen 3



- Checks for the following hardware inputs:**
- To Process RTD (always displayed in °C)
 - From Process RTD (always displayed in °C)
 - Spare Input
 - Remote Setpoint (always displayed in °C)
 - Remote Start
 - Phase Monitor

Diagnostics Screen 4



- Checks for the following hardware outputs:**
- Pump, Heater, and Output Signals.
 - Pump Contactor
 - Heater Contactor
 - Heater SSR (or spare, as shown)

Diagnostics Screen 5



- Checks for the following parameters:**
- Additional Outputs, Alarms, Cooling Valve, and Temperature Retransmit
 - Closed Circuit Vent Valve (or spare, as shown)
 - Mold Purge Valve (or spare, as shown)
 - Alarm
 - Modulating valve signals
 - Process Temperature Retransmit Signal

Setting Up Your Controller (Continued)

Diagnostics Screen 6

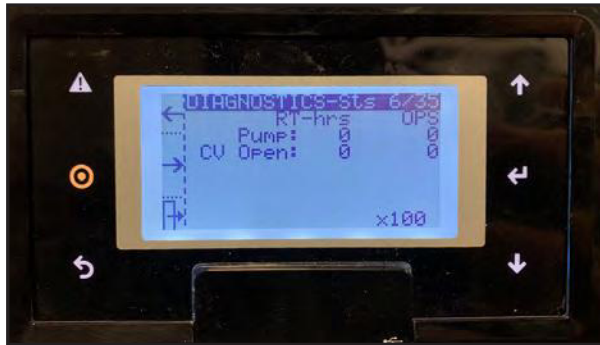

Checks for the following parameters:

Runtime Hours for Pump and Cooling Valve.
Number of Operations for Pump and Cooling Valve, and
Mold Purge (if installed).

Diagnostics Screen 7



Checks for the following parameters:

RunTime Hours for Heater Contactor and Heater SSR (if installed).
Number of Operations for Heater Contactor and Heater SSR (if installed).

Diagnostics Screen 8



Checks for the following parameters:

Number of Operations Logged for the Pump Overload
Number of Alarms Recorded
Number of High Temperature Warnings/Alarms
Number of Phase Monitor trips (if installed)

Diagnostics Screen 9



Checks for the following parameters:

Cooling Water Temperature
Cooling Utilization, long-term average
Heating Utilization, long-term average
Last Alarm Duration
Low Pressure Hours

Setting Up Your Controller (Continued)

Diagnostics Screen 10



Checks for memory writes, loop time to execute the program and the power supply voltage.

NOTE: You can set the maximum loop time to a lower number in order to trap the longest loop time while monitoring.

Diagnostics Screen 11

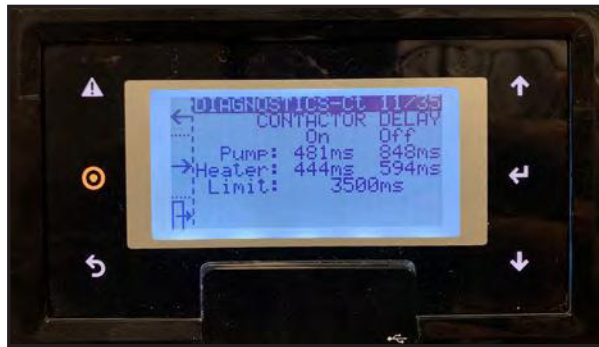

Pump and Heater Contactor Delay

This is the measured delay between the contactor coil output actuation, and receiving the auxiliary input from each respective contactor. Any duration longer than the limit will result in a contactor alarm.

Diagnostics Screens 12 through 15 Alarm Counts

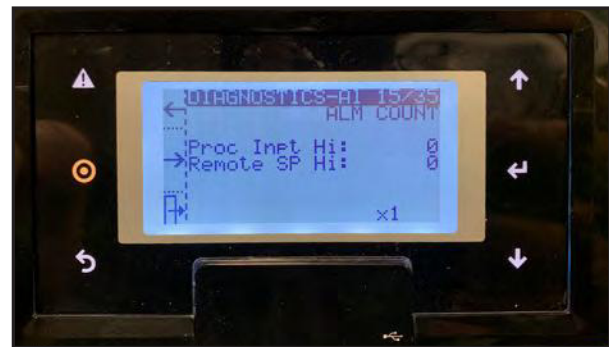
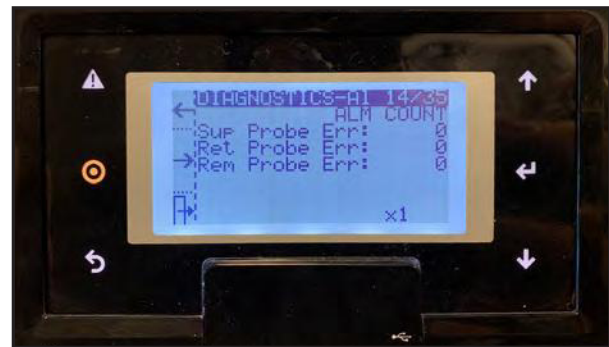
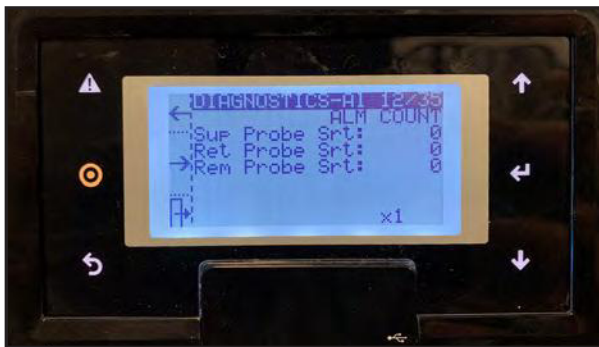

Setting Up Your Controller (Continued)

Diagnostics Screens 16 through 22 Alarm Counts

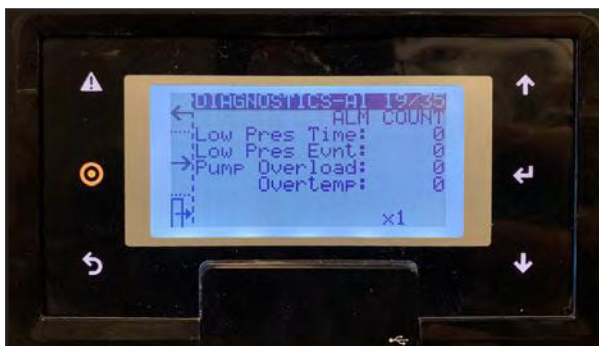

Setting Up Your Controller (Continued)

Diagnostics Screen 23



PID Parameters

This display is helpful to diagnose PID operation by showing different values being used to properly regulate the temperature.

Diagnostics Screen 24



Hardware, Firmware, Operating System, and Software Versions.

Diagnostics Screen 25

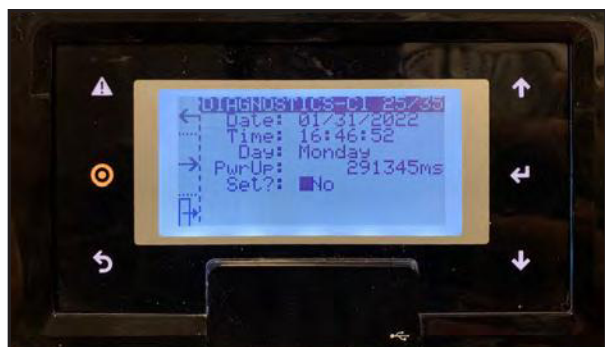

Date/Time/Day with option to “Set” new time. Power Up time is also displayed.

Diagnostics Screens 26 thru 35 display communication bits for Modbus RTU communications diagnostics.

Page intentionally left blank.

Operation

The RQT Advanced Control	4-2
Start-up.....	4-3
Starting the RQT Advanced.....	4-4
Stopping the RQT Advanced.....	4-5
Normal Operation	4-6
Auto Cool Stop Sequence Initiation	4-6
Using the Optional Mold Purge Option	4-7

The RQT Advanced Control

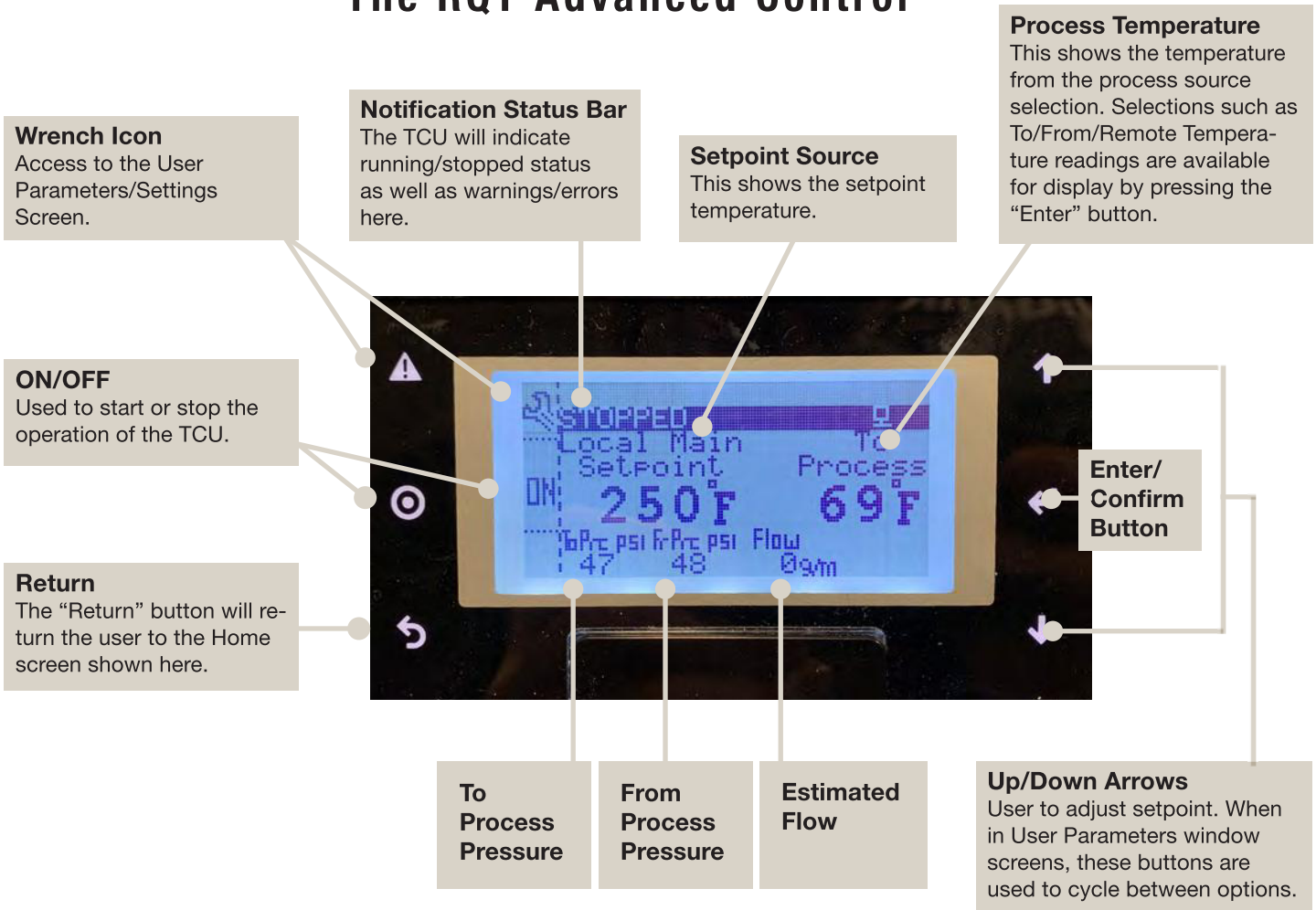

Note that the 6 buttons on the sides is the user interface used to control the functionality and settings of the machine. Depending on the window currently displayed on screen, the icons may change respectively altering the functionality of the button. Please be aware of the icon displayed on screen when using the controller in order to determine the action that will take place.

 **NOTE:** This control is NOT a touchscreen. The buttons on the outside frame of the display must be used to navigate and make changes.

Start-up

Every unit is factory set to deliver water in accordance with the standard operating specifications for that particular unit. Due to variables involved with different applications and different installations, minor adjustments may be required during the initial start-up to ensure proper operation. We recommend a qualified technician perform the start-up and that they follow the start-up procedure in sequence. The following serves as a checklist for the initial start-up and for subsequent start-ups if the unit is out of service for a prolonged time.



WARNING: Electrical Hazard



Before performing maintenance or repairs on this product, disconnect and lock out electrical power sources to prevent injury from unexpected energization or start-up. A lockable device must be used to isolate this product from potentially hazardous electricity.



WARNING:



This equipment contains hot water or coolant under pressure. Accidental release of this hot fluid may result in steam formation and can cause personal injury and or property damage.



WARNING:



This equipment may contain fan blades or other sharp edges. Make sure all fan guards and other protective shields are securely in place.



WARNING:



The exposed surfaces of motors, heater tubes, and other fluid circuit components can be very hot and can cause burns if touched with unprotected hands.



CAUTION: Disconnect and lock out incoming power before installing, servicing, or maintaining the equipment. Connecting power to the main terminal block energizes the entire electric circuitry of the unit. A power supply provides 24 VDC control power. Electric power at the main disconnect should be shut off before opening access panels for repair or maintenance.



CAUTION: Wear eye protection when installing, maintaining, or repairing the equipment to protect against any sparks, debris, or fluid leaks.



CAUTION: Wear protective gloves when installing, maintaining, or repairing the equipment to protect against any sparks, debris, or fluid leaks.



CAUTION: To prevent improper pump performance due to reverse rotation, connect L1-L2-L3 in the A-B-C phase sequence.



CAUTION: Do not shut off To Process, From Process, Cooling Water In, or Cooling Water out valves while this equipment is operating. Equipment failure and/or serious injury could result.



CAUTION: Always keep the cover in place while operating this equipment. Internal surfaces may be extremely hot. Only qualified personnel should remove this cover.





CAUTION: Ground the unit properly in compliance with local and national codes.





NOTE: Setpoint range can be expanded for your application based on process fluids used (Glycol). Maximum temperature setting may be dependent upon cooling water pressure.

Starting the RQT Advanced

 **NOTE:** If minimum 30 psi cooling water supply pressure is not achieved, the TCU will automatically adjust the maximum temperature based off of the provided supply pressure.

 **NOTE:** If the coolant pressure warning banner pops up, verify that the cooling water supply is connected properly and that the water pressure is at least 30 PSI or greater. Significantly higher pressures will be required to support high setpoints on 300°F {149°C} units.

 **NOTE:** Setpoint range can be expanded for your application based on process fluids used (Glycol). Maximum temperature setting may be dependent upon cooling water pressure.

 **NOTE:** Critical alarms cannot be silenced. Typically they also require a power cycle to reset.

Before starting the RQT Advanced, verify that the system has been installed correctly for your application. *See the Installation section of this User Guide.*

1 Turn on the water supply to the RQT Advanced. The supply pressure must be at least 25 psi for most units. Check for leaks in the cooling water and process fluid lines before continuing.

2 Turn on main power to the RQT Advanced.

- The controller display will illuminate to indicate the control has power.

3 Set the temperature setpoint to 40°F (4.4°C) if the RQT Advanced's process lines were recently reconfigured, or if you suspect excessive air is in the process lines.

4 Press the ON button.



The unit initiates a 64-second followed by a 30 second (or as otherwise defined by user parameters) venting sequence.

- The pump starts after the venting cycle is over. The notification banner will pop up at the top of the controller to indicate that the venting cycle has been completed, at which point the pump will start running.
- Normal operation begins. The heater turns on if the actual temperature is below setpoint. The cooling valve opens if the actual temperature is above setpoint.

 **NOTE:** Both venting stages will be skipped if the process temperature is above the vent bypass temperature, and the RQT Advanced will subsequently start the pump immediately in the "RUNNING" state.

5 Set the setpoint to the desired temperature, using up/down arrows.

6 If the Alarm LED turns on, select "Yes" next to "Silence alarm" on the alarm screen.

Refer to the Troubleshooting section for more information.

To select the proper setpoint of the system, follow this procedure:

1 The temperature setpoint can be quickly adjusted by tapping on the Up and Down arrows on the right of the screen when on the main page.



Stopping the RQT Advanced



WARNING: Electrical Shock and Hot Surface Hazards



Before attempting maintenance of any kind on the RQT Advanced, you must stop the unit, disconnect and lockout the main power supply, and allow the unit to cool to less than 100°F {38°C}.

You must shut down the RQT Advanced whenever you:

- Change the water hookups.
- Perform maintenance on the process machine.
- Purge the process circuit of the water or fluid.
- Perform routine or preventative maintenance.
- Observe a condition that requires troubleshooting.
- Relocate, ship or store the unit.

To shut down the unit during a normal interruption in production process, where no maintenance will be performed:

- 1 Press the OFF button.**  If Shutdown Auto Cool Stop is enabled, the auto cool stop feature will cool the TCU down before shutting down. If immediate shut down is needed, press OFF again.

To shut down the unit to change water hookups or perform maintenance:

Use the Auto Cool Stop feature and allow the RQT Advanced to cool itself to less than 100°F {38°C}. To use Auto Cool Stop - select the More button, and Auto Cool Stop. This will allow the auto cool stop feature to cool the TCU down prior to shut down. If immediate shut down is needed, press STOP again.

- 1 Press the OFF button**  .
- 2 Shut off the cooling water supply, and relieve any pressure in the unit** by lifting the relief valve lever and removing the drain plug on the bottom of the heater tank; then drain the unit of all fluid. The cooling water inlet hose can be removed to provide additional draining. For relocation and storage, make sure you eliminate all water from the tank (mixing and heater), to decrease the chance of excessive corrosion or freezing.
- 3 Once the unit is cool and depressurized, remove the water hookups.**

Normal Operation

For normal operation of the RQT Advanced, set the setpoint on the temperature controller using the the Up and Down arrow key buttons to the right of the screen.



Auto Cool Stop Sequence Initiation

The sequence reduces the water temperature before the unit shuts off to extend the life of the pump seal. During this sequence, the cooling valve opens and the pump runs for 600 seconds or until the temperature reaches 100°F {38°C} (default settings), whichever occurs first. Pressing the Stop button during a Auto Cool Stop cool-down sequence stops the sequence.

Using the Optional Mold Purge Option

Optional purge valve (Mold Purge) clears the process lines of fluid using compressed air. The valve is operated by an optional manual purge button on the control panel.

IMPORTANT: Before purging the process lines, be sure that the cooling water source feed is closed. If the feed is open and the air line has a higher pressure than the cooling water, air may be injected into the cooling water system. If the cooling water pressure is higher than the air line, cooling water may be injected into the air line.

- 1** Ensure that the unit is Stopped by going to the Home screen and checking the status bar on the top left hand corner. If not, press the button corresponding to the OFF button.
- 2** Shut off the cooling water supply valve to prevent fresh water from entering the process.
- 3** Press the button corresponding to MP (mold purge) to activate mold purge for 3 seconds.
- 4** The mold purge timeout can be modified on user parameter screen 8 before returning back to the main screen to activate mold purge.

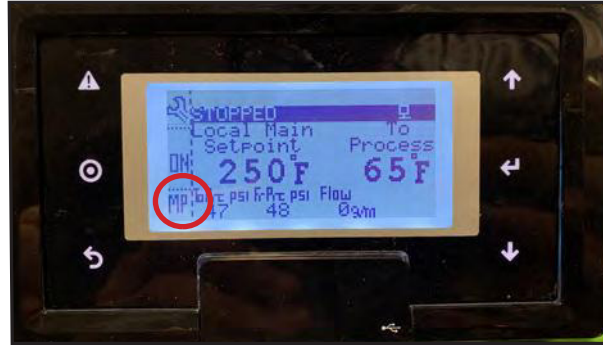

Hold "MP" Button for 3 seconds to activate mold purge.

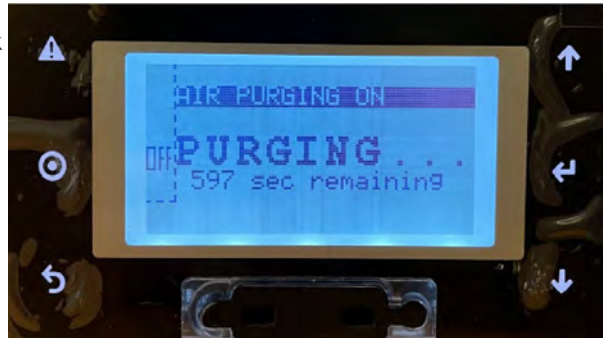

Mold purge "On" Screen

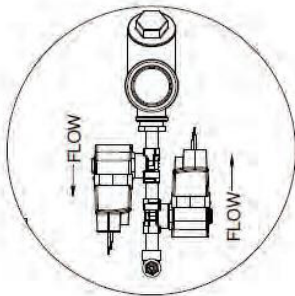

DETAIL C

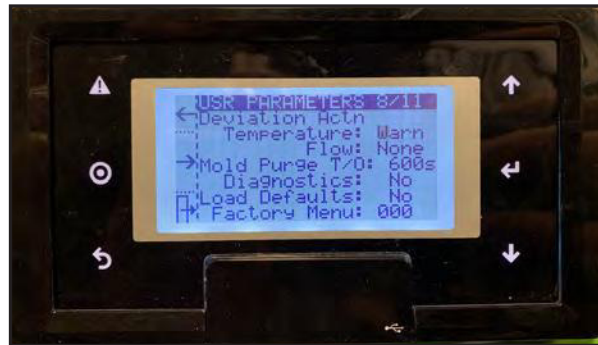

Mold Purge Time Out can be modified on User Parameters page. Default value is 600 seconds.

Page intentionally left blank.

Maintenance

Maintenance of Your RQT Advanced 5-2

Preventive Maintenance Schedule..... 5-2

Accessing the RQT Advanced Enclosure 5-3

Removing the Pump Motor and Seal (3/4 to 2 Hp, any frequency and 3 HP, 60 Hz units) 5-4

Reassembling the Pump Motor and Seal (3/4 to 2 Hp, any frequency and 3 HP, 60 Hz units) 5-7

Removing the Pump Motor and Seal (3 Hp, 50Hz and 5 to 10 Hp, any frequency units) 5-9

Reassembling Pump Motor and Seal (3 Hp, 50Hz and 5 to 10 Hp, any frequency units)5-11

Resetting Pump Overload.....5-12

Replacing Pump Overload5-12

Replacing the Heater Contactor.....5-13

Replacing the Controller Boards.....5-14

System Maintenance5-14

RQT Advanced Controller Abbreviations/Acronyms5-15

Diagnostics Screens.....5-15

Replacing RTDs5-16

Repairing Cooling Valves5-17

Replacing Immersion Heaters5-18

Removing the Pump5-22

Maintenance of Your RQT Advanced

Depending on which features, options, and additions you ordered with your unit, your maintenance procedures and necessities may differ from what is shown in this User Guide. Please note that all illustrations, photos, and instructions are based on a typical configuration of a RQT Advanced. Always refer to the wiring diagrams and other documentation - including manuals from the manufacturer of any valves, heat exchangers, and parts used on your RQT Advanced - when completing any maintenance or troubleshooting tasks.

If you have any questions or concerns about your RQT Advanced, feel free to call Customer Service for assistance.

Preventive Maintenance Schedule

Once the unit is in service, we suggest following the maintenance procedures as closely as possible. The importance of a properly established preventive maintenance program cannot be overemphasized. Taking the time to follow these simple procedures will result in substantially reduced downtime, reduced repair costs, and an extended useful lifetime for the unit. RQT Advanced water temperature controllers are essentially maintenance-free. However, to maintain the best performance, we recommend the following maintenance schedule.

- **Daily or as often as necessary**
 - Check for leaks in cooling and process lines.**
Before and during operation, you should inspect the unit and all plumbing lines for leaks. If a leak develops, stop the RQT Advanced and repair it.
 - Keep the unit and the area around it clean.**
Check for and remove lint, dust, or other obstructions on the unit, especially around air vent areas. Keep floor around the unit dry. The RQT Advanced exchanges air from in front of, underneath, on top and beside the unit, so make sure that nothing is against the front, bottom, top or sides of the unit that would inhibit proper ventilation around the unit. A cooling fan pulls cool air into the cabinet from the floor, so be sure to keep its intake clear of debris.
- **Quarterly (every 3 months) or as often as necessary**
 - Inspect power cords, wires, and electrical connections.**
Check for loose or frayed wires, burned contacts, and signs of overheated wires. Check exterior power cords to the main power source and from the electrical box to the pump and heating elements. Check the ground wire and RTD connections. Replace any wire that appears damaged or has worn or cracked insulation. Vacuum excessive dust from electrical cabinet.
- **Every five years**
 - Replace cooling fan in electrical cabinet.**

Accessing the RQT Advanced Enclosure

Depending on which features, options, and additions you ordered with your unit, your RQT Advanced may appear different and operate differently from the illustrations and photos shown in this User Guide.



WARNING: Electrical Shock and Hot Surface Hazards.

Before attempting maintenance of any kind on the RQT Advanced, you must stop the unit, disconnect and lockout the main power supply, and allow the unit to cool to less than 100°F {38°C}.



The lockout procedure must include all energy sources:

- Electrical power supply
- Compressed air supply
- Potential energy from suspended parts
- Pressurized process fluid loop
- Cooling fluid supply
- Cooling fluid return
- Stored thermal energy
- Any other source that might cause unexpected mechanical movement or energy release



NOTE: Refer to the “Zero Energy State (ZES)” section of this User Guide for more information.

To access the RQT Advanced enclosure:

- 1 Remove the top panel by using an 1/8” Allen key to remove the (4) screws.**



- 2 Remove right side panel by using an 1/8” Allen key to remove the (5) screws securing the panel.**



- 3 Set the top panel and side panel out of the way for maintenance procedures.**



Removing the Pump Motor and Seal (3/4-2 HP, any frequency and 3HP, 60 Hz units)

Tools Required

- 9/16-inch wrench
- Flat-blade screwdriver
- 5/8 inch deep socket
- Press for removal of pump seal

Time Required

45 Minutes

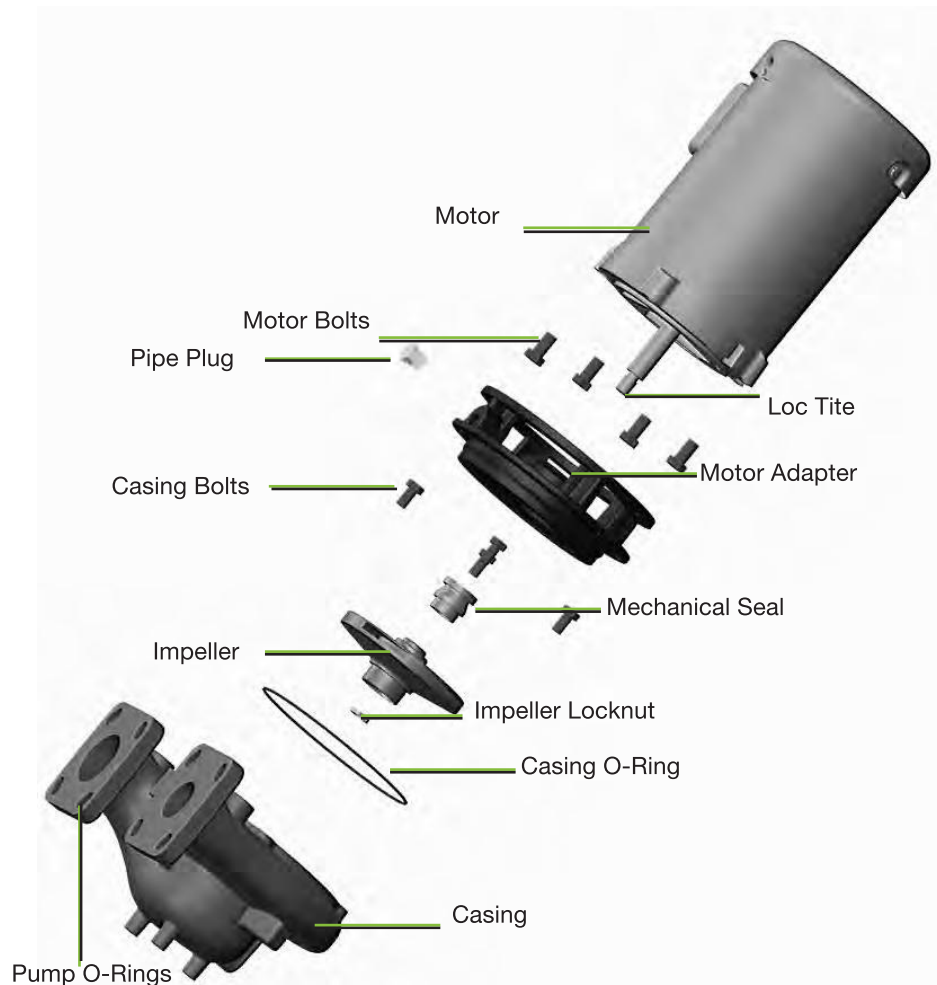

If the pump motor or seal ever needs to be replaced, the following procedure can be used on all models with 3/4-2 HP, any frequency and 3 HP, 60 Hz motors for disassembly:

- 1** Using a 9/16-inch wrench, remove the four (4) casing bolts that hold the motor and impeller adapter assembly to the RQT Advanced.
- 2** Remove the motor and adapter from the pump adapter to volute.
- 3** Remove the casing O-ring. Inspect for damage or wear. If in good condition, set aside for re-use. If a new part is needed, contact **IMS Company for Parts**.

(Continued)

Removing the Pump Motor and Seal (3/4-2 HP, any frequency and 3HP, 60 Hz units) Continued

4 Remove the dust cap from the bell end motor housing to expose the motor shaft.



5 Using a locking pair of pliers, grip the flat sides of the motor shaft.



6 Remove impeller lock nut using a 5/8 inch deep socket. The lock nut is secured in place with a high performance thread locker. A significant amount of torque will be required to break it free. Use the locking pliers at the other end of the shaft to prevent shaft rotation when removing the lock nut and impeller. Standard clockwise thread is used.



7 Unscrew the impeller from the shaft.



(Continued)

Removing the Pump Motor and Seal (3/4-2 HP, any frequency and 3HP, 60 Hz units) (Continued)

- 8** Slide the rotating half of the shaft seal off of the shaft. Be careful not to contaminate, chip, or scratch seal surfaces if it is to be re-used. Set seal half aside for re-use if appropriate.



- 9** Using a 9/16-inch wrench, remove the four (4) casing bolts.



- 10** Slide motor adapter off of motor shaft.

- 11** Press stationary half of pump seal out of motor adapter, being careful not to damage rubber diameteral seal or rotating/non-rotating seal interface surface. Set seal half aside for re-use if appropriate.

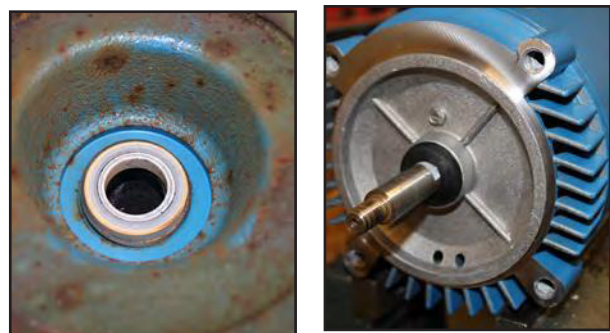

Reassembling the Pump Motor and Seal (3/4-2 HP, any frequency and 3HP, 60 Hz units)

The following procedure can be used on all models with 3/4-2 HP, any frequency and 3HP, 60 Hz motors for reassembly:

- 1 Gently press stationary half of pump seal into motor adapter** being careful to not damage rotating / non-rotating seal interface surface.
- 2 Slide motor adapter assembly on to motor shaft.**

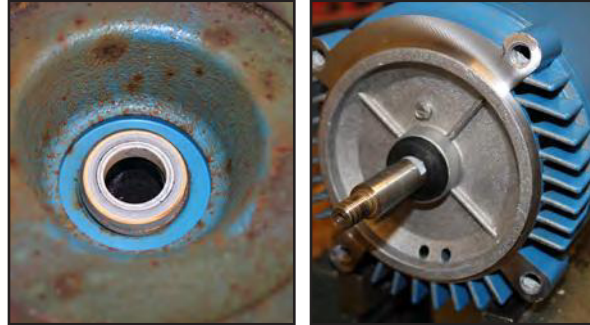

Tools Required

- 9/16-inch wrench
- Flat-blade screwdriver
- 5/8 inch deep socket
- Blue Loc-Tite® (271)
- P-80 Lubricant

Time Required

25 Minutes

- 3 Install and tighten the 4 bolts to 20 ft-lbs {27.12 N·m}.** While tightening the bolts, be careful to maintain the motor adapter perpendicular to the shaft.

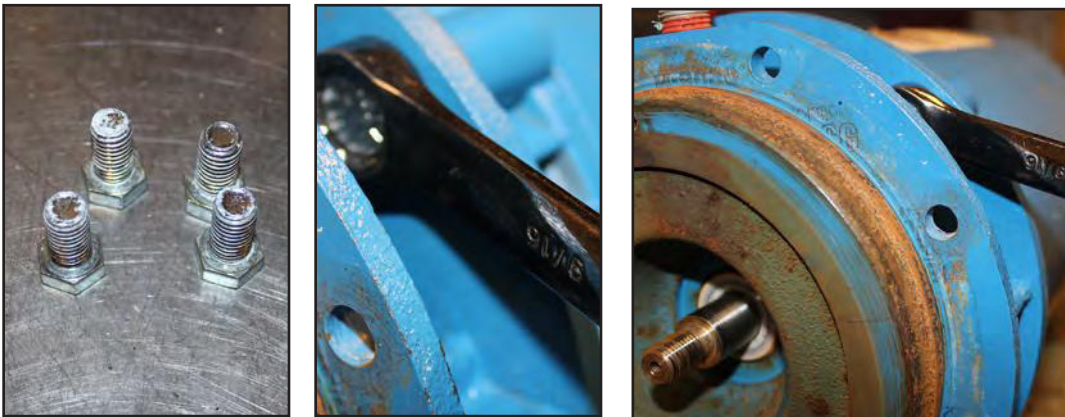

- 4 Slide the rotating portion of the shaft seal onto the shaft** with the spring on the impeller side. Lubricate Motor Shaft with P-80 Lubricant. Then slide the rotating portion of the shaft seal onto the shaft with the spring on the impeller side.



(Continued)

Reassembling the Pump Motor and Seal (3/4-2 HP, any frequency and 3HP, 60 Hz units)(Continued)

- 5** Align the impeller and screw on to shaft.



- 6** Place a small amount of Blue Loc-Tite #271 on the shaft end thread.



- 7** Install the impeller jam nut on the shaft, and tighten to 12 ft-lbs {16.27 N·m}. Use a locking pair of pliers to grip the flat side of the shaft at the motor bell end. Re-install dust cap if removed during disassembly.

- 8** Place pump to adapter o-ring on motor adapter. Locate the o-ring as far up the adapter as possible such that it sits tight to the angle formed by the mounting flange.



- 9** Locate the motor and motor adapter assembly on the pump volute. Install the 4 bolts, tightening to 20 ft-lbs {27.12 N·m}.

Removing the Pump Motor and Seal

(3 HP, 50Hz and 5 to 10 HP, any frequency units)

Tools Required

- 9/16-inch wrench
- Flat-blade screwdriver
- 9/16-inch deep socket

Time Required

20 Minutes

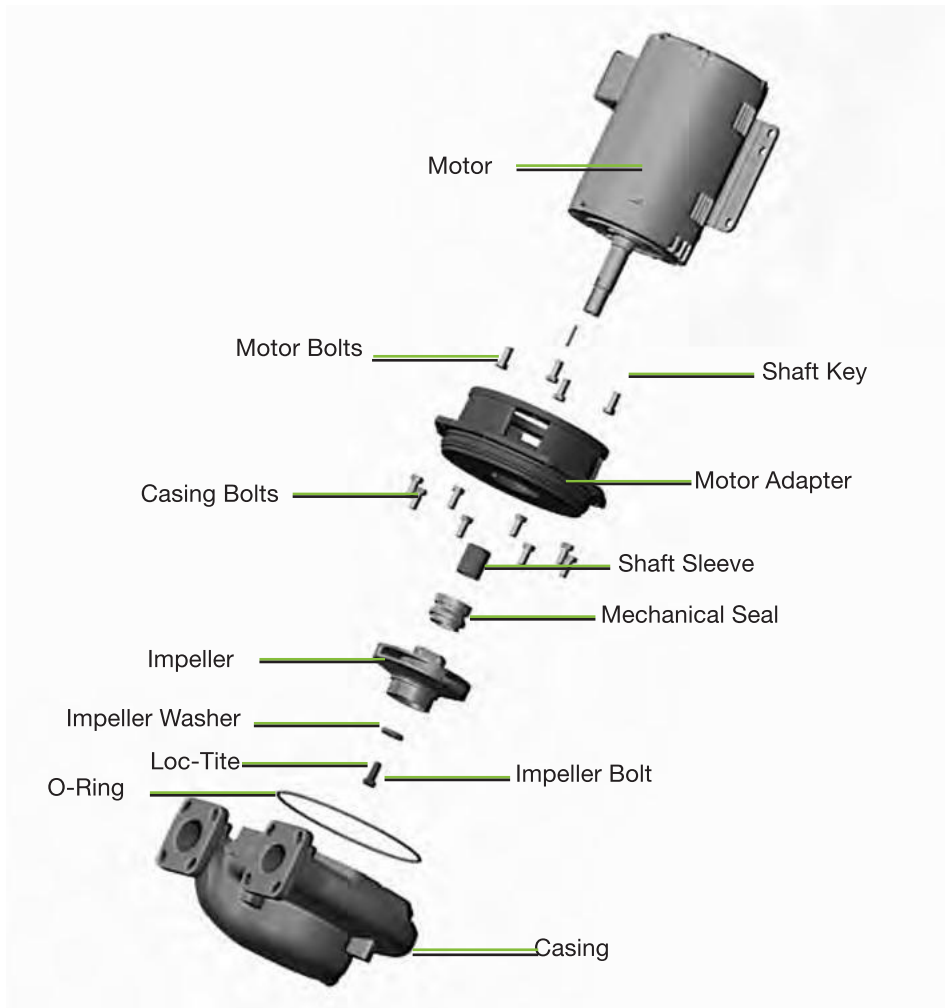

The following procedure can be used on all models with 3 HP, 50Hz and 5 to 10 HP, any frequency pump motors for disassembly:

- 1 Remove eight (8) pump casing bolts using a 9/16-inch wrench.**
- 2 Remove motor and adapter from casing.**
- 3 Inspect pump casing to adapter o-ring for damage.** If appropriate obtain a replacement from the IMS Company Parts Department.
- 4 Remove impeller bolt and washer using a 9/16-inch deep socket.** The bolt is secured in place with a high performance thread locker. A significant amount of torque will be required to break it free. The impeller may be clamped on the smallest diameter round section behind the witness line of the casing interface only. Do not damage the outside surface where the close clearance between the casing and impeller exists.

(Continued)

Removing the Pump Motor and Seal (3 HP, 50Hz and 5 to 10 HP, any frequency units) (Continued)



This area interfaces with volute

Witness line

Clamp in this region if needed

- 5** Pull the impeller away from the shaft by using two flat-blade screw drivers to pry the back side of the impeller away from the motor adapter.
- 6** Slide rotating half of shaft seal off of shaft. Be careful not to contaminate, chip or scratch seal surfaces if it is to be re-used. Set seal half aside for re-use if appropriate.
- 7** Slide shaft sleeve off of shaft.
- 8** Remove 4 motor bolts using 9/16-inch wrench.
- 9** Slide motor adapter off of motor shaft.
- 10** Press stationary half of pump seal out of motor adapter being careful not to damage rubber diametral seal or rotating / non-rotating seal interface surface. Set seal half aside for re-use if appropriate.

Reassembling Pump Motor and Seal

(3 HP, 50Hz and 5 to 10 HP, any frequency units)

The following procedure can be used on all models with 3 HP, 50Hz and 5 to 10 HP, any frequency motors for disassembly:

- 1** Gently press stationary half of pump seal into motor adapter being careful not damage rotating / non-rotating seal interface surface.
- 2** Slide motor adapter assembly on to motor shaft.
- 3** Install and tighten the four (4) bolts to 37 ft lbs {50.12 N·m}. Holding the motor adapter on to the motor being careful to maintain the adapter perpendicular to the shaft.
- 4** Slide the shaft sleeve over top of shaft.
- 5** Lubricate Motor Shaft with P-80 Lubricant.
- 6** Slide the rotating portion of the shaft seal on to the shaft with the spring on the impeller side.
- 7** Align the impeller and slide on to shaft while ensuring the shaft key is in place.
- 8** Place a small amount of Blue Loc-Tite #271 on the impeller bolt thread.
- 9** Install the impeller bolt and washer on the shaft, tighten to 20 ft-lbs {27.12 N·m}.
- 10** Place pump to adapter o-ring on motor adapter if removed. Locate the o-ring in the groove on the adapter without residual twist.
- 11** Locate the motor and motor adapter assembly on the pump casing. Install the eight (8)bolts, tightening to 37 ft-lbs {50.12 N·m}.

Tools Required

- 9/16-inch wrench
- Flat-blade screwdriver
- 9/16-inch deep socket
- Blue Loc-Tite[®] (271)
- P-80 Lubricant

Time Required

60 Minutes

Tools Required

- ☐ Phillips Screwdriver

Resetting Pump Overload

The pump motor overload is located inside the unit's electrical enclosure.

- 1 Disconnect and lockout the main power.**
- 2 Open the electrical enclosure door.** Turn the screw on the front panel counterclockwise to open.
- 3 Check the overload.** Press the blue button to attempt to reset the overload. If it clicks, the overload was tripped. Verify that the overload trip point is set as specified by the electrical power prints.

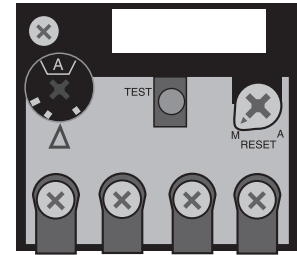

Replacing Pump Overload

- 1 Disconnect and lockout the main power.**
- 2 Open the electrical enclosure door.** Turn the screw on the front panel counterclockwise to open.
- 3 Locate the pump overload module** attached beneath the pump motor starter.
- 4 Disconnect the three power leads** from the overload module to the pump motor. Note the color/placement of each lead and label as needed.
- 5 Disconnect auxiliary wiring on the overload module.**
- 6 Remove the overload module.** Loosen the three screws that connect the overload module to the motor contactor. Pull the overload module down to release it from the starter.
- 7 Reverse these steps to install the new overload module.**
- 8 Set the module reset mode to M for manual.**
- 9 Set the proper FLA trip point.** Trip point will be shown on electrical prints
- 10 Push reset button on overload** to ensure it is not in the tripped state.
- 11 Verify that pump rotation is correct** (*see Installation section of this User Guide*).

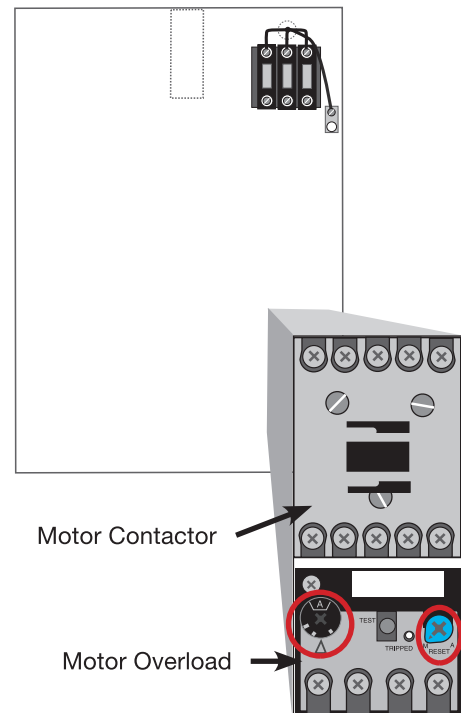

Replacing the Heater Contactor

CAUTION: Before performing maintenance or repairs on this product, you should disconnect and lockout electrical power sources to prevent injury from unexpected energization or start-up. A lockable device may be provided to isolate this product from potentially hazardous electricity.

WARNING: Before removing lockout devices and returning switches to the ON position, make sure that all personnel are clear of the machine, tools have been removed and all safety guards reinstalled.

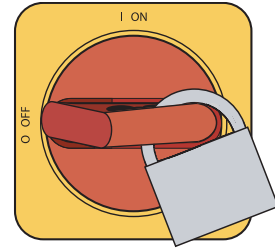

The heater contactors should be replaced if:

- The controller prompts you to replace the heater contactor because it is worn out.
- You have checked the continuity and found that resistance across the coil equals zero ohms or is an open circuit.
- You have checked continuity of the power legs (with the heater wires disconnected) and find them continuously connected. Or, you have checked continuity across the power legs and find an open circuit even when the coil is energized.

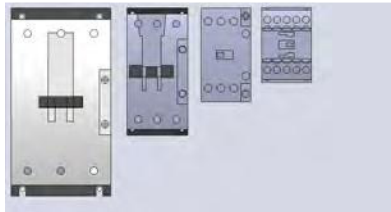

To replace the heater contactor:

- 1 Disconnect and lockout the main power.**
- 2 Open the electrical enclosure door.** Turn the latch on the front panel counterclockwise to open.
- 3 Disconnect wires from the heater contactor.** Make sure you label the wires to ensure you can connect them correctly to the new contactor.
- 4 Remove the contactor** by removing the mounting screws that hold it in place.
- 5 Reverse this procedure starting with step 4 to install the new contactor.** Make sure the wires are connected correctly.

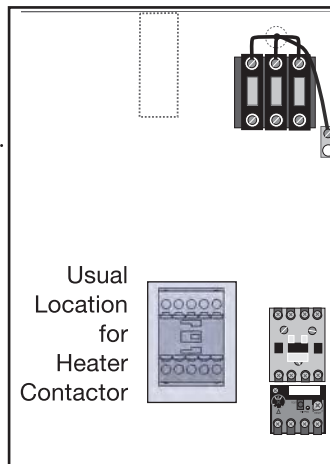

Check electrical prints for actual layout and location.

Replacing the Controller Boards

The HMI Controller on the Enhanced units can be replaced if necessary.

To Remove the HMI Controller:

- 1** Disconnect and lockout the main power supply.
- 2** Unplug all wired connections to the HMI controller.
- 3** Remove the faceplate around the controller to reveal two inset screws.
- 4** Using a Phillips Head screw driver, remove both screws.
- 5** Pull the HMI Controller out from the front of the TCU.

To Reinstall the HMI Controller:

- 1** Insert the HMI Controller in the electrical panel cut-out.
- 2** Screw on both Phillips head screws to mount the controller to the panel.
- 3** Reconnect wired connections to the HMI controller.

System Maintenance

In the event that a system reset to factory settings is required, there is an option available provided to reset the TCU parameters.

- 1** To access the factory defaults, press the button corresponding to the wrench icon and navigate to the 8th window screen on the user parameters window.

- 2** Press the enter button to move down the list to the “Load Defaults” menu item.

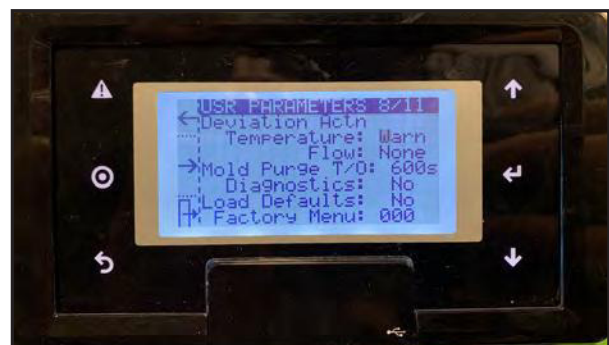

RQT Advanced Controller Abbreviations/ Acronyms

To Prc – To Process (Supply)
Fr Prc – From Process (Return)
MP – Mold Purge
DGS – Diagnostics
g/m – gallons per minute
PV – Process Value
Dflt – Default
Disp – Display
Cnt – Count
WR - Warning
Alm - Alarm
R/T – Ride-through
Dly – Delay
Dev – Deviation
SP – Setpoint
Dyn Max SP – Dynamic Max SetPoint
Rem Start – Remote Start
Analog Procs Ret – Analog Process Retransmit

Diagnostics Screens

Fr Prc Px – From Process Pressure (Return)
Pump OL – Pump Overload
Pump Aux – Pump Contactor Auxilliary
Heater Ax – Heater Contactor Auxilliary
To Prc Px – To Process Pressure (Supply)
To Pr RTD – To Process RTD (Supply)
Fr Pr RTD – From Process RTD (Return)
Rem StPt – Remote Setpoint
Rem Str – Remote Start
Phs Mon – Phase Monitor
Cool Vlv – Cooling Valve
Temp Ret – Temperature Retransmit
RT-hrs – Run Time Hours
OPS – Operations
CV – Cooling Valve
Cooling LTA – Cooling Utilization Long Term Average
Heating LTA – Heating Utilization Long Term Average
Lst Alm Dur – Last Alarm Duration
Low Pres – Low Pressure
Mem W – Memory Writes
Mx Lp Time – Max Loop Time
PS Volts – Power Supply Volts
Sup Probe Srt/Opn/Err – Supply (To Process) Probe Short/Open/Error
Ret Probe Srt/Opn/Err – Return (From Process) Probe Short/Open/Error
Rem Probe Srt/Opn/Err – Remote Probe Short/Open/Error
Proc Inpt Hi – Process Input High
Remote SP Hi – Remote SetPoint High
Ntwrk HB Lost – Network HeartBeat Lost

Replacing RTDs



WARNING: Hot Surfaces

Allow the RQT Advanced to cool to below 100°F {38°C} before servicing the unit.



To replace an RTD:

- 1 Disconnect and lockout the main power.**
- 2 Drain the unit of all water** through the drain plug in the rear of the unit. *Refer to “To shut down the unit to change water hookups or perform maintenance” earlier in the Operation section of this User Guide.*
- 3 Remove the unit’s top panel and open the electrical enclosure.** *See section “Accessing the RQT Advanced Enclosure.”*
- 4 Remove the side panels.** *See section “Accessing the RQT Advanced Enclosure.”*
- 5 Remove the RTD.** Loosen the compression nut to slide the RTD out of the casing. Disconnect the RTD wires at the terminal strip. Note locations of wires before disconnecting. Remove wire ties.
- 6 Install the new RTD.** Insert the tip of the new RTD at least 1 inch into the tank, attempting to locate the tip of the RTD in the center of the fluid stream. Tighten the compression nut. Thread the leads with the wire bundle leading to the electrical enclosure.
- 7 Re-secure RTD wires to the various wire mounts** to keep the wire from contacting the heater housing, pump casing, or motor housing. Wire the RTD wires to secure them within the electrical cabinet.
- 8 Do not trim off the extra wire. Leave it coiled like the the original RTD so as to not influence circuit resistance. Strip and attach RTD leads to the terminal strip at locations noted in step 4.** Polarity does not matter.

IMPORTANT: Always refer to the wiring diagrams that came with your RQT Advanced to locate specific electrical components. Illustrations in the User Guide are intended to be representative only.

 **NOTE:** You may want to test the resistance of the new RTD to ensure it aligns with the table in the previous section.

 **NOTE:** For units with pressure transducers, (ie all enhanced and touchscreen units), there will be a plug in place of the pressure switch.

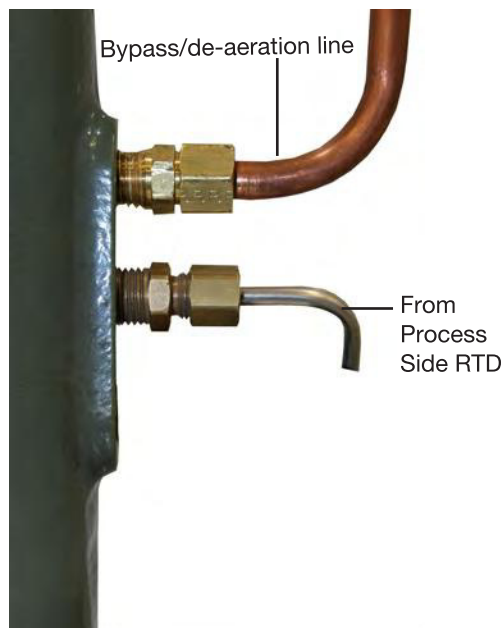
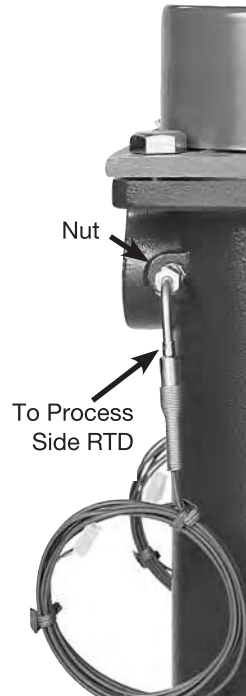

Repairing Cooling Valves

Every RQT Advanced has a valve assembly that controls the cooling water out flow. Occasionally, this valve assembly may need to be cleaned, if clogged with debris, or replaced. The steps below details these procedure.



WARNING: Electrical Shock and Hot Surface Hazard



Before attempting maintenance of any kind on the RQT Advanced, you must stop the unit; disconnect and lockout the main power supply; and allow the unit to cool to 100°F {38°C}.



NOTE: Always refer to the connection diagram sticker on the back of your machine for proper connection locations. Each unit now has a connection diagram sticker (like this one) that shows where connections are made on the back of the unit.

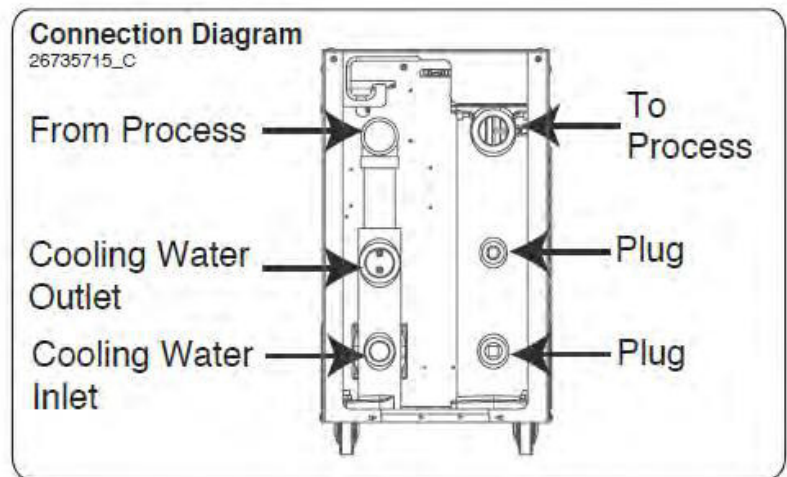

IMPORTANT: Always refer to the wiring diagrams that came with your RQT Advanced to locate specific electrical components. Illustrations in the User Guide are intended to be representative only.

- 1 Shut off the incoming cooling water.**
- 2 Drain the unit of all water** through the drain plug in the rear of the unit.
- 3 Observe and record the existing orientation of the valve, its actuator, and override handle so that it can be re-installed in the identical orientation.**
- 4 Remove the connections to the cooling water out.**
- 5 Disconnect and lockout main power.** Follow zero mechanical state procedures to ensure that equipment is disconnected from any other pressurized or operational systems (compressed air, pressurized water lines, etc.).
- 6 Remove the valve from the cooling water out line.**
- 7 Disassemble the valve.**
- 8 Inspect and clean or repair the valve body assembly.** Remove foreign particles and replace damaged parts as necessary.
- 9 Reassemble the valve and other components.** Reassemble in reverse order. Seal all pipe fittings with pipe sealant. Check that all flows are in the correct direction. Check for leaks before resuming operation.

Replacing Immersion Heaters



WARNING: Electrical Shock and Hot Surface Hazard

Before attempting maintenance of any kind on the RQT Advanced, you must stop the unit; disconnect and lockout the main power supply; and allow the unit to cool to 100°F {38°C}.



- 1 Disconnect all energy sources including cooling water in, electrical power, and compressed air.**

Refer to the Zero Energy State information in the installation section of this User Guide.

- 2 Remove the top panel of the RQT Advanced.**

Rotate heater cap if necessary for proper knockout position. *See section “Accessing the RQT Advanced Enclosure.”*

- 3 Remove the heater cap.** Use a Phillips screwdriver to remove the heater connection box lid.

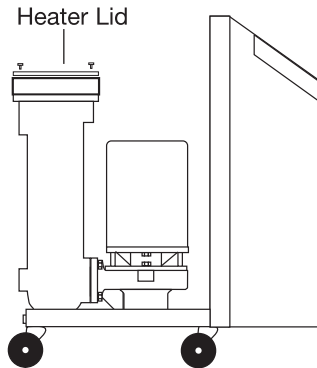

- 4 Remove the heater wiring harness.** Label the wiring layout of the heater terminals; wires are labeled as 2T1, 2T2, 2T3 and GND. (They may also be labelled as 3T1, 3T2, 3T3 if dual-fed or 48kw units.)

Record the position of bus links, jumpers, and feed wires so they can be replaced in exactly the same manner on the replacement heater.

Then unscrew the nuts on the cable connectors and remove the wires.

- 5 Drain the RQT Advanced.** *Refer to “To shut down the unit to change water hook-ups or perform maintenance” earlier in the Operation section of this User Guide.*

- 6 Remove the four bolts that hold the heater element in place.** Use a 9/16-inch socket.

- 7 If heater feed wires terminate in hexagonal termination studs, remove those studs from the heater with a nut driver and re-install on the replacement heater.**

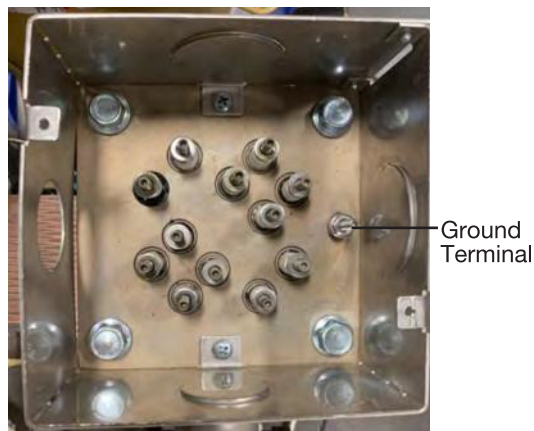

Heater on the TCU Showing Hexagonal Terminal Studs

(Continued)

Replacing Immersion Heaters (Continued)

- 8** To Re-install add-on heater termination stud use a nut driver and use the same torque you would use to tighten the standard stud nut. **Do not overtighten!**

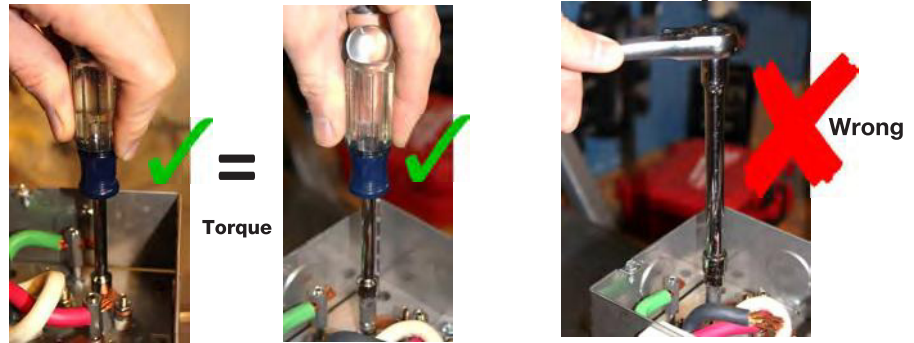

- 9** When tightening the set screw, be sure to use a backer wrench on the add-on termination stud.

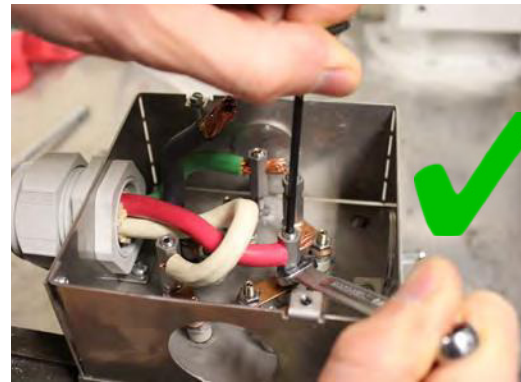

- 10** Copper conductors should protrude 1/8" to 3/8" beyond the exit from the add-on heater stud, being careful to not approach a stud of an opposing phase or grounded surface.



Replacing Immersion Heaters (Continued)

Parts

	Description	Usage
	Small Add-On Heater Termination Stud	For #8 & #6 wires.
	Medium Add-On Heater Termination Stud	For #4 wires.

Wire gauge vs. kW vs Voltage reference:

HEATER: 460VAC				
kW	FLA	FLEX CORD	ADD-ON TERMINATIONS?	FEED
9	11.3	#14/4	No	Single
12	15.1	#12/4	No	Single
18	22.6	#8/4	Yes-Small 3350240701, x4	Single
24	30.1	#6/4	Yes-Small 3350240701, x4	Single
36	45.2	#4/4	Yes-Medium 3350240702, x4	Single
HEATER: 208-230VAC				
kW	FLA	FLEX CORD	ADD-ON TERMINATIONS?	FEED
9	22.6	#8/4	Yes-Small 3350240701, x4	Single
12	30.1	#6/4	Yes-Small 3350240701, x4	Single
18	45.2	#4/4	Yes-Medium 3350240702, x4	Single
24	60.2	#6/4	Yes-Small 3350240701, x7	Dual
HEATER: 575VAC				
kW	FLA	FLEX CORD	ADD-ON TERMINATIONS?	FEED
9	9.0	#14/4	No	Single
12	12.0	#12/4	No	Single
18	18.1	#10/4	No	Single
24	24.1	#8/4	Yes-Small 3350240701, x4	Single
36	36.1	#4/4	Yes-Medium 3350240702, x4	Single
HEATER: 400VAC				
kW	FLA	FLEX CORD	ADD-ON TERMINATIONS?	FEED
9	13.0	#12/4	No	Single
12	17.3	#10/4	No	Single
18	26.0	#8/4	Yes-Small 3350240701, x4	Single
24	34.6	#4/4	Yes-Medium 3350240702, x4	Single

(Continued)

Replacing Immersion Heaters (Continued)

11 Lift the heating element out of the heater tank. Lift the element straight up.

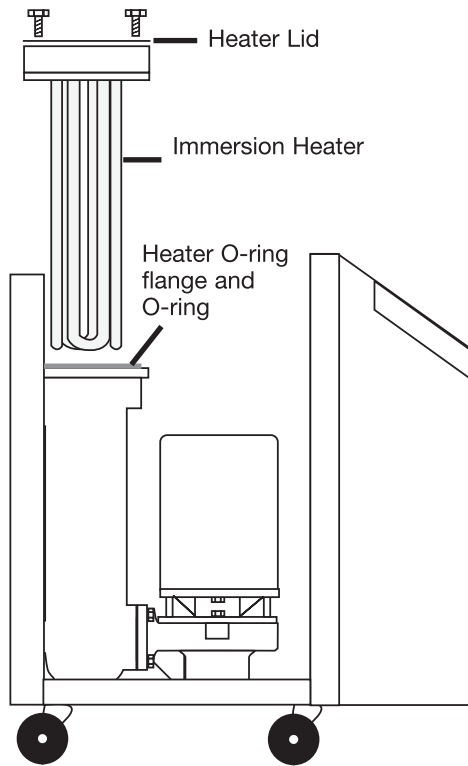

12 Clean the heater tank. Remove any rust or solids that may have built up before inserting the heater elements.

13 Replace the heater O-ring if it is worn or cracked.

14 Clean the O-ring flange or replace it.

15 Reverse these steps to install the new heater element and reassemble the unit.

IMPORTANT: Note heater orientation - grounding bolt location is crucial to proper operation. Heater ground should be at the back of unit. Heater orientation should be such that the ground is located at the rearmost portion of the RQT Advanced (opposite the open knockout of the electrical box).

Troubleshooting

Before Beginning.....	6-2
A Few Words of Caution	6-3
Identifying the Cause of a Problem	6-4
Controller Warnings	6-5
Controller Alarms	6-7
Unit Will Not Power Up.....	6-10
Troubleshooting.....	6-11
Replacing the Heater Contactor.....	6-13
Checking the RTD	6-13

Before Beginning

You can avoid most problems by following the recommended installation, operation and maintenance procedures outlined in this User Guide. If you have a problem, this section will help you determine the cause and tell you how to fix it.

Before you begin troubleshooting:

- Find any wiring, parts, and assembly diagrams that were shipped with your equipment. These are the best reference for correcting a problem. The diagrams will note any custom features or options not covered in this User Guide.
- Verify that you have all instructional materials related to the RQT Advanced. Additional details about troubleshooting and repairing specific components are found in these materials.
- Check that you have the manual for other equipment connected in the system. Troubleshooting may require investigating other equipment attached to, or connected with the RQT Advanced.

A Few Words of Caution

 **WARNING: Improper installation, operation or servicing may result in equipment damage or personal injury.**

This equipment should only be installed, adjusted, and serviced by qualified technical personnel who are familiar with the construction, operation, and potential hazards of this type of machine.

All wiring, disconnects, and fuses should be installed and adjusted by qualified electrical technicians in accordance with electrical codes in your region. Always maintain a safe ground. Do not operate the equipment at power levels other than what is specified on the machine serial tag and data plate.

 **WARNING: Electrical Hazard**

 Before performing maintenance or repairs on this product, disconnect and lock out electrical power sources to prevent injury from unexpected energization or start-up. A lockable device has been provided to isolate this product from potentially hazardous electricity.

 **WARNING: Compressed Air Hazard**

If you use compressed air, you must wear eye protection and observe all OSHA and other safety regulations pertaining to the use of compressed air. Bleed off pressure before servicing equipment.

 **WARNING: Hot Surface and Liquid Hazards.**

Before attempting maintenance of any kind on the RQT Advanced, you must stop the unit, disconnect and lockout the main power supply, and allow the unit to cool to less than 100°F {38°C}.



Identifying the Cause of a Problem

 **NOTE:** Additional troubleshooting help can be found in the documentation manuals included with this User Guide.

The Troubleshooting section covers problems directly related to the operation and maintenance of the RQT Advanced. This section does not provide solutions to problems that originate with other equipment. Additional troubleshooting help can be found in manuals supplied with the other equipment.

The status bar located on the top left hand corner of the controller will indicate a warning or an alarm. The audible alarm will also activate to further alert personnel of issues. If the optional visual alarm package is installed, the strobe light will be activated as well.



Warning Example - A prompt with additional information on the warning can be found by tapping on the button corresponding to “WR”.

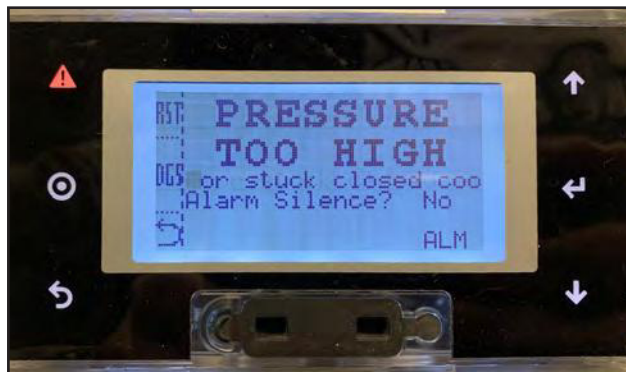

Alarm Example - The alarm prompt will take up the entire screen and prompt the user if they would like to silence the alarm.

RST - Reset Alarm
DGS - Diagnostics

If you choose to return to the Home screen, you can view the alarm again by pushing the “ALM” button.

Additionally, entering the diagnostics window can show alarm and warning counts that have been logged on the controller to assist with troubleshooting the root cause of the problem.



WARNING: Always disconnect and lock out the main power source before opening the RQT Advanced or its electrical enclosure.



Also disconnect air and water supply lines as needed.

Controller Warnings

Warning	Possible Cause	Solution
Pump Overload	Pump current high. Pump differential pressure too low.	Check fluid loop for too much flow. Reset pump overload protector.
Heater Contactor Life Cycle	Heater contactor is near to the end of life.	Replace contactor soon.
To Process RTD Prob Open	Failed probe not controlling, so unit operation not affected.	Check for OPEN CIRCUIT in "To Process" RTD temperature probe or wiring.
To Process RTD Prob Short	Failed probe not controlling, so unit operation not affected.	Check for SHORT CIRCUIT in "To Process" RTD temperature probe or wiring.
To Process RTD Prob Error	Failed probe not controlling, so unit operation not affected.	Check for CHANNEL FAULT in "To Process" RTD temperature probe circuit.
From Process RTD Prob Open	Failed probe not controlling, so unit operation not affected.	Check for OPEN CIRCUIT in "From Process" RTD temperature probe or wiring.
From Process RTD Prob Short	Failed probe not controlling, so unit operation not affected.	Check for SHORT CIRCUIT in "From Process" RTD temperature probe or wiring.
From Process RTD Prob Error	Failed probe not controlling, so unit operation not affected or transducer.	Check for CHANNEL FAULT in "From Process" RTD temperature probe circuit.
To Process Pressure Sensor Open	HIGH SIGNAL or OPEN/SHORT CIRCUIT in To Process Pressure Transducer wiring or transducer.	Check for HIGH SIGNAL or OPEN/SHORT CIRCUIT in To Process Pressure Transducer wiring or transducer itself.
To Process Pressure Sensor Short	LOW SIGNAL or OPEN/SHORT CIRCUIT in To Process Pressure Transducer wiring.	Check for LOW SIGNAL or OPEN/SHORT CIRCUIT in To Process Pressure Transducer wiring or transducer itself.
To Process Pressure Sensor Error	CHANNEL FAULT in To Process Pressure Transducer wiring or transducer.	Check for CHANNEL FAULT in To Process Pressure Transducer wiring or transducer itself.
Flash Memory Warning	Flash memory writes are excessive.	Contact the Service department.
High Temp Deviation	Blocked cooling valve or heater contactor failed.	Check for blocked cooling valve or failed heater contactor.
Low Temp Deviation	Cooling valve stuck open or heater contactor failed.	Check for stuck open cooling valve or failed heater contactor.
High Pressure	Too much pressure in cooling loop.	Check for stuck closed cooling valve or too much cooling water pressure.

Controller Warnings (continued)

Warning	Possible Cause	Solution
High Flow Deviation	Too much flow in process lines.	Check for appropriate warning trigger settings.
Low Flow Deviation	Process lines are blocked or a valve is closed.	Check the process lines and appropriate trigger setting.
System Pressure Below Min	Process fluid pressurization supply is too low or there is a leak in the process loop.	Check cooling water supply pressure. Unit will automatically restart when pressure returns.
System Pressure Not High Enough	Process fluid pressurization supply is too low for the actual system temperature.	Check cooling line pressure.
Setpoint Too High	Setpoint is too high for current system pressure.	Reduce the setpoint or increase the cooling water supply pressure.

Controller Alarms

Alarm	Possible Cause	Solution
Over Temperature Fault	The process heater or SSR heatsink (if installed) is too hot.	<p>Disconnect power to the unit!</p> <p>Check for low flow or failed cooling fan.</p> <p>Wait for unit to cooldown before attempting to restart.</p>
Heater Contactor Stuck Closed	Heater contactor could be welded.	<p>Disconnect power to the unit!</p> <p>Check for a welded heater contactor / Replace heater contactor.</p>
Temperature Over Factory Limit	There may be a problem with cooling flow or excessive heating.	<p>Disconnect power to the unit!</p> <p>Check for cooling flow or excessive heating.</p>
Electric Power Fault	Problem with incoming electrical power.	Test for reverse phase rotation, phase loss or low leg.
Pump Contactor Stuck Closed	Pump contactor may be welded or have an improperly energized coil.	<p>Check pump contactor for always energized coil circuit.</p> <p>Check for a welded pump contactor / Replace pump contactor.</p>
Heater Contactor Stuck Open	Heater contactor may have open coil circuit or internal armature mechanical binding.	Check heater contactor for open coil circuit or internal armature mechanical binding.
Pump Contactor Stuck Open	Pump contactor may have open coil circuit or internal armature mechanical binding.	Check pump contactor for open coil circuit or internal armature mechanical binding.
Temperature Under Factory Limit	Cooling valve may be stuck open or there is no heating.	Check for stuck open cooling valve or no heating.
System Pressure Too High	Incoming water pressure may be too high or cooling valve is stuck closed.	Check incoming water pressure or stuck closed cooling valve.
Temperature Over User Setting	Cooling flow may be blocked or heating is excessive.	Check for blocked cooling flow or excessive heating.
Temperature Under User Setting	Cooling valve may be stuck open or there is no heating.	Check for stuck open cooling valve or no heating.
Low Pressure Shut-down	Low process inlet pressure for an excessive amount of time.	Check city/tower/pressure supply or for a leak in process loop.
Low Pressure Events	Repeated low pressure events.	Check city/tower/pressure supply.

(Continued)

Controller Alarms (Continued)

Alarm	Possible Cause	Solution
Pump Overload Tripped	Pump differential pressure too low.	Check fluid loop for too much flow.
	Pump current high.	Reset pump overload protector.
To Process RTD Probe Open Circuit	Possible OPEN CIRCUIT in "To Process" RTD temperature probe or wiring.	Check for OPEN CIRCUIT in "To Process" RTD temperature probe or wiring.
To Process RTD Probe Short Circuit	Possible SHORT CIRCUIT in "To Process" RTD temperature probe or wiring.	Check for SHORT CIRCUIT in "To Process" RTD temperature probe or wiring.
To Process RTD Probe Error	Possible CHANNEL FAULT in "To Process" RTD temperature probe circuit.	Check for CHANNEL FAULT in "To Process" RTD temperature probe circuit.
From Process RTD Probe Open Circuit	Possible OPEN CIRCUIT in "From Process" RTD temperature probe or wiring.	Check for OPEN CIRCUIT in "From Process" RTD temperature probe or wiring.
From Process RTD Probe Short Circuit	Possible SHORT CIRCUIT in "From Process" RTD temperature probe or wiring.	Check for SHORT CIRCUIT in "From Process" RTD temperature probe or wiring.
From Process RTD Probe Error	Possible CHANNEL FAULT in "From Process" RTD temperature probe circuit.	Check for CHANNEL FAULT in "From Process" RTD temperature probe circuit.
Remote RTD Probe Open Circuit	Possible OPEN CIRCUIT in "Remote" RTD temperature probe or wiring.	Check for OPEN CIRCUIT in "Remote" RTD temperature probe or wiring.
Remote RTD Probe Short Circuit	Possible SHORT CIRCUIT in "Remote" RTD temperature probe or wiring.	Check for SHORT CIRCUIT in "Remote" RTD temperature probe or wiring.
Remote RTD Probe Error	Possible CHANNEL FAULT in "Remote" RTD temperature probe circuit.	Check for CHANNEL FAULT in "Remote" RTD temperature probe circuit.
Analog Setpoint High	Possible HIGH SIGNAL or OPEN/SHORT CIRCUIT in analog SETPOINT TEMPERATURE wiring or transmitter.	Check for HIGH SIGNAL or OPEN/SHORT CIRCUIT in analog SETPOINT TEMPERATURE wiring or transmitter.
Analog Setpoint Low	Possible LOW SIGNAL or OPEN/SHORT CIRCUIT in analog SETPOINT TEMPERATURE wiring or transmitter.	Check for LOW SIGNAL or OPEN/SHORT CIRCUIT in analog SETPOINT TEMPERATURE wiring or transmitter.

Controller Alarms (Continued)

Alarm	Possible Cause	Solution
Analog Setpoint Error	Possible CHANNEL FAULT in analog SETPOINT TEMPERATURE wiring or transmitter.	Check for CHANNEL FAULT in analog SETPOINT TEMPERATURE wiring or transmitter.
From Process Pressure Sensor Open Circuit	Possible HIGH SIGNAL or OPEN/SHORT CIRCUIT in From Process pressure transducer wiring or transducer itself.	Check for HIGH SIGNAL or OPEN/SHORT CIRCUIT in From Process pressure transducer wiring or transducer itself.
From Process Pressure Sensor Short Circuit	Possible LOW SIGNAL or OPEN/SHORT CIRCUIT in From Process pressure transducer wiring or transducer itself.	Check for LOW SIGNAL or OPEN/SHORT CIRCUIT in From Process pressure transducer wiring or transducer itself.
From Process Pressure Sensor Error	Possible CHANNEL FAULT in From Process pressure transducer wiring or transducer itself.	Check for CHANNEL FAULT in From Process pressure transducer wiring or transducer itself.
High Temp Deviation	Possible blocked cooling valve or failed heater contactor.	Check for blocked cooling valve or failed heater contactor.
Low Temp Deviation	Possible stuck open cooling valve or failed heater contactor.	Check for stuck open cooling valve or failed heater contactor.
High Flow Deviation	Too much flow in process lines.	Check for appropriate warning trigger settings.
Low Flow Deviation	Process lines are blocked or a valve is closed.	Check the process lines and appropriate trigger setting.
System Pressure Below Min	Process fluid pressurization supply is too low or there is a leak in the process loop.	Check cooling water supply pressure.
System Pressure Not High Enough	Process fluid pressurization supply is too low for the actual system temperature.	Check cooling line pressure.

Unit Will Not Power Up

If you press the control power button and the HMI Controller does not light, you have a problem with the main power circuit or the unit's temperature controller.



WARNING: Electrical Shock Hazard
Disconnect and lockout the main power supply before proceeding.

Symptom	Possible Cause	Solution
Applying power does not illuminate the temperature controller display.	Is power reaching the RQT Advanced?	Verify that the main power supply and any customer-installed electrical disconnect or emergency stop devices are in the ON position. Verify correct electrical connections between the unit and the power supply. Replace any damaged wires or cables.
	Is the correct voltage reaching the RQT Advanced?	Check the electrical requirements on the unit nameplate. Verify correct main supply voltage to the unit and the 24 VDC secondary voltage supply.

Troubleshooting

Symptom	Possible Cause	Solution
<p>Alternating overheating and overcooling or rapid cycling from heat to cool.</p>	<p>Poor water flow.</p>	<p>Check connectors and increase size if necessary. If there are a large number of hoses and/or they are long, try to shorten hose runs and use as large of a hose as possible to minimize water-circuit pressure drop. If quick disconnects with check valves are used, remove the check valves to reduce pressure drop through water circuit.</p>
	<p>Poor connection or failure of RTD.</p>	<p>Check connection, replace if necessary.</p>
	<p>Failure of the microprocessor.</p>	<p>Replace controller.</p>
<p>Unable to heat properly.</p>	<p>Cooling valve is stuck in the open position.</p>	<p>Flush out the cooling valve by adjusting the Setpoint up and down several times to open and close the cooling valve. If this does not work, stop the unit and turn off the electric power, shut off the cooling source, and take the valve apart for cleaning or replacement.</p>
	<p>Leaking connection and/or the manual pressure relief valve is in an open condition.</p>	<p>Check for leaks and replace any faulty valves.</p>
	<p>Immersion heater is inoperative</p>	<p>Have a qualified electrician check to see if the heater and/or heater contactor are functioning correctly and replace any defective components.</p>
	<p>Microprocessor controller failure.</p>	<p>Replace controller.</p>
	<p>Failure of RTD.</p>	<p>Replace RTD.</p>

Troubleshooting (Continued)

IMPORTANT: Always refer to the wiring diagrams that came with your RQT Advanced to locate specific electrical components. Illustrations in the User Guide are intended to be representative only.

Symptom	Possible Cause	Solution
Unable to cool properly.	Cooling water supply is not sufficient.	Check to make sure the cooling water supply is of sufficient temperature, volume and pressure for the unit.
	Drain (cooling water return line) is not sufficient.	Check the drain (cooling water return line) to ensure there is no restriction preventing water flow to the drain (cooling water return line).
	Cooling valve is inoperative.	Check the drain (cooling water return line) and see if you can feel or hear a change in the flow as the cooling valve open and closes. If you cannot hear or feel the flow it is likely the valve has failed. Replace valve if necessary.
	Plugged heat exchanger (only on models with heat exchanger option).	Clean or replace heat exchanger.
	High backpressure in the cooling water system.	Reduce backpressure.
Heater failure.	Unit not filled with water.	Fill unit with water.
	Faulty heater.	Replace heater.
	Plugged heater tube / flow restriction.	Clear obstruction.
Pressure relief valve leaks.	The pressure of the incoming cooling water pressure exceeds the pressure rating of the pressure relief valve.	Install a pressure-reducing valve on the incoming cooling water line. Review the start-up procedure for cooling water pressure requirements at various operating temperatures.
	Pressure relief valve stuck in open position.	Replace valve.

Replacing the Heater Contactor

See Replacing the Heater Contactor in the Maintenance Section of this User Guide.

Checking the RTD



WARNING: Electrical Shock Hazard



Only qualified service personnel who have been trained on electrical testing and the procedures for avoiding the hazards should diagnose or correct problems that require opening the unit with power on.

The RQT Advanced uses a Pt1000 RTD to monitor the “to process” and “from process” temperature. It also uses a Pt1000 RTD for the remote RTD (if equipped). One Pt1000 RTD is installed in the wall of the heater tank at the “to process” outlet. The other is installed in the mixing tank (or heat exchanger) near the “from process” outlet.

To check a RTD after a sensor error:

- 1 Disconnect and lockout the main power.**
- 2 Open the electrical enclosure door.** Turn the screw on the front panel counterclockwise to open.
- 3 Remove RTD wiring terminal strip.** Refer to the wiring diagrams that came with your unit.
- 4 Verify the resistance of the RTD using a VOM. Polarity does not matter. If incorrect, replace.** *Refer to the table on the next page.*

Checking the RTD (Continued)

Pt1000

Temp T	Resistance at T	Resistance at T+1°F	Resistance at T+2°F	Resistance at T+3°F	Resistance at T+4°F	Resistance at T+5°F	Resistance at T+6°F	Resistance at T+7°F	Resistance at T+8°F	Resistance at T+9°F	Temp T
°F	Ohms	Ohms	Ohms	Ohms	Ohms	Ohms	Ohms	Ohms	Ohms	Ohms	°C
30°F	996Ω	998Ω	1,000Ω	1,002Ω	1,004Ω	1,007Ω	1,009Ω	1,011Ω	1,013Ω	1,015Ω	-1.1°C
40°F	1,017Ω	1,020Ω	1,022Ω	1,024Ω	1,026Ω	1,028Ω	1,030Ω	1,033Ω	1,035Ω	1,037Ω	4.4°C
50°F	1,039Ω	1,041Ω	1,043Ω	1,046Ω	1,048Ω	1,050Ω	1,052Ω	1,054Ω	1,056Ω	1,058Ω	10.0°C
60°F	1,061Ω	1,063Ω	1,065Ω	1,067Ω	1,069Ω	1,071Ω	1,074Ω	1,076Ω	1,078Ω	1,080Ω	15.6°C
70°F	1,082Ω	1,084Ω	1,087Ω	1,089Ω	1,091Ω	1,093Ω	1,095Ω	1,097Ω	1,099Ω	1,102Ω	21.1°C
80°F	1,104Ω	1,106Ω	1,108Ω	1,110Ω	1,112Ω	1,115Ω	1,117Ω	1,119Ω	1,121Ω	1,123Ω	26.7°C
90°F	1,125Ω	1,127Ω	1,130Ω	1,132Ω	1,134Ω	1,136Ω	1,138Ω	1,140Ω	1,143Ω	1,145Ω	32.2°C
100°F	1,147Ω	1,149Ω	1,151Ω	1,153Ω	1,155Ω	1,158Ω	1,160Ω	1,162Ω	1,164Ω	1,166Ω	37.8°C
110°F	1,168Ω	1,170Ω	1,173Ω	1,175Ω	1,177Ω	1,179Ω	1,181Ω	1,183Ω	1,185Ω	1,188Ω	43.3°C
120°F	1,190Ω	1,192Ω	1,194Ω	1,196Ω	1,198Ω	1,200Ω	1,203Ω	1,205Ω	1,207Ω	1,209Ω	48.9°C
130°F	1,211Ω	1,213Ω	1,215Ω	1,217Ω	1,220Ω	1,222Ω	1,224Ω	1,226Ω	1,228Ω	1,230Ω	54.4°C
140°F	1,232Ω	1,235Ω	1,237Ω	1,239Ω	1,241Ω	1,243Ω	1,245Ω	1,247Ω	1,249Ω	1,252Ω	60.0°C
150°F	1,254Ω	1,256Ω	1,258Ω	1,260Ω	1,262Ω	1,264Ω	1,266Ω	1,269Ω	1,271Ω	1,273Ω	65.6°C
160°F	1,275Ω	1,277Ω	1,279Ω	1,281Ω	1,283Ω	1,286Ω	1,288Ω	1,290Ω	1,292Ω	1,294Ω	71.1°C
170°F	1,296Ω	1,298Ω	1,300Ω	1,303Ω	1,305Ω	1,307Ω	1,309Ω	1,311Ω	1,313Ω	1,315Ω	76.7°C
180°F	1,317Ω	1,320Ω	1,322Ω	1,324Ω	1,326Ω	1,328Ω	1,330Ω	1,332Ω	1,334Ω	1,336Ω	82.2°C
190°F	1,339Ω	1,341Ω	1,343Ω	1,345Ω	1,347Ω	1,349Ω	1,351Ω	1,353Ω	1,355Ω	1,358Ω	87.8°C
200°F	1,360Ω	1,362Ω	1,364Ω	1,366Ω	1,368Ω	1,370Ω	1,372Ω	1,374Ω	1,377Ω	1,379Ω	93.3°C
210°F	1,381Ω	1,383Ω	1,385Ω	1,387Ω	1,389Ω	1,391Ω	1,393Ω	1,396Ω	1,398Ω	1,400Ω	98.9°C
220°F	1,402Ω	1,404Ω	1,406Ω	1,408Ω	1,410Ω	1,412Ω	1,414Ω	1,417Ω	1,419Ω	1,421Ω	104.4°C
230°F	1,423Ω	1,425Ω	1,427Ω	1,429Ω	1,431Ω	1,433Ω	1,435Ω	1,438Ω	1,440Ω	1,442Ω	110.0°C
240°F	1,444Ω	1,446Ω	1,448Ω	1,450Ω	1,452Ω	1,454Ω	1,456Ω	1,459Ω	1,461Ω	1,463Ω	115.6°C
250°F	1,465Ω	1,467Ω	1,469Ω	1,471Ω	1,473Ω	1,475Ω	1,477Ω	1,479Ω	1,482Ω	1,484Ω	121.1°C
260°F	1,486Ω	1,488Ω	1,490Ω	1,492Ω	1,494Ω	1,496Ω	1,498Ω	1,500Ω	1,502Ω	1,505Ω	126.7°C
270°F	1,507Ω	1,509Ω	1,511Ω	1,513Ω	1,515Ω	1,517Ω	1,519Ω	1,521Ω	1,523Ω	1,525Ω	132.2°C
280°F	1,527Ω	1,530Ω	1,532Ω	1,534Ω	1,536Ω	1,538Ω	1,540Ω	1,542Ω	1,544Ω	1,546Ω	137.8°C
290°F	1,548Ω	1,550Ω	1,552Ω	1,555Ω	1,557Ω	1,559Ω	1,561Ω	1,563Ω	1,565Ω	1,567Ω	143.3°C
300°F	1,569Ω	1,571Ω	1,573Ω	1,575Ω	1,577Ω	1,579Ω	1,582Ω	1,584Ω	1,586Ω	1,588Ω	148.9°C

Appendix A

Contact IMS:

IMS Company
10373 Stafford Rd.
Chagrin Falls, Ohio 44023-5296

US & Canada: 1-800-537-5375

Mexico: 001-888-304-1307

Specialists: 1-866-467-9001

Fax: 1-888-288

www.imscomany.com

email: sales@imscompany.com

Before You Call...

If you do have a problem, please complete the following checklist before calling Thermal Care:

- Make sure you have all model, control type from the serial tag, and parts list numbers for your particular equipment. Service personnel will need this information to assist you.
- Make sure power is supplied to the equipment.
- Make sure that all connectors and wires within and between control systems and related components have been installed correctly.
- Check the troubleshooting guide of this manual for a solution.
- Thoroughly examine the instruction manual(s) for associated equipment, especially controls. Each manual may have its own troubleshooting guide to help you.
- Check that the equipment has been operated as described in this manual.
- Check accompanying schematic drawings for information on special considerations.

Appendix B

PID Parameters

The TIMS Hydra RQT Advanced features a PID (“proportional-integral-derivative”) control-loop algorithm implemented in the programming of the controller board. This algorithm is used to achieve the proper temperature of the process fluid quickly and accurately. The following tables and paragraphs describe its operation.

The default factory PID parameters loaded into the RQT Advanced should work well under most applications. However, due to a wide variety of situations and system requirements, these parameters can be adjusted to best serve a particular application.

PID Default Parameters			
	Default	Controller Parameter	Comments
Proportional Band	7	P - Band	<i>Smaller</i> number = more aggressive proportional cooling response.
Integral Gain	5.0	I - Gain	<i>Smaller</i> number = more aggressive integral cooling response.
Derivative Gain	20.0	D - Gain	<i>Larger</i> number = more aggressive derivative cooling response.
Integral Active Band	7	I Active Band	Integral Active Band defines the band over which the integral response is active. Typically set similar as the proportional band to prevent excessive integral windup.

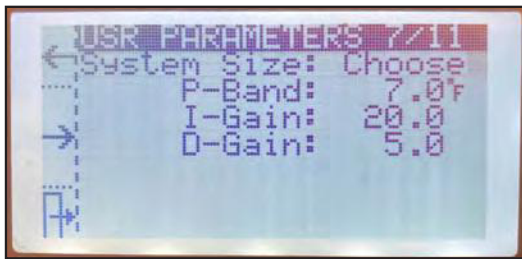

Selecting Tuning Parameters

The controller has three pre-configured tuning parameter sets one of which should allow optimum temperature control. Following is a description of each of the choices available to an operator.

Slow Responding system

Select the slow setting “Large” for large systems for parameter “System Size”. More than 80 gallons {303 liters} of water and more than 5,600 lbs {2,540 kg} of steel would be considered a large system. This setting has the smallest proportional band (3°F {-16 °C}), which allows larger changes in the control output when the process temperature is far from setpoint.





Normal Responding System

“Normal” is the factory default tuning setting, as it will cover the majority of applications. This setting is appropriate for systems with 10 to 80 gallons {38 to 303 liters} of water and 700 to 5,600 lbs {318 to 2,540 kg} of steel. The default value for the normal proportional band is 7°F {-14°C}.

PID Parameters (Continued)

Fast Responding system

Select the fast setting “Small” for small systems for parameter “System Size”. Less than 10 gallons {38 liters} and 700 pounds {318 kg} of steel might be considered a small system. This setting has the largest proportional band (15°F {-14°C}), which allows a fast response to more desirable deviations between the process variable and setpoint. This system is typical for small RQT Advanced units with small molds or other process machinery.

- 1** If the RQT Advanced is running, stop it by pressing STOP .
- 2** Press the  button to access User Parameters.
- 3** Press the “NEXT”  button to get to screen 5/6, which shows the PID parameters.
- 4** Select “Small”, “Normal”, or “Large” for the parameter “System Size” and then press “Enter” . The additional parameters below will automatically adjust to appropriate values.
- 5** Press “Exit”  when finished.

Proportional

The main driver for the RQT Advanced control loop is the proportional response. Proportional logic is very simple—it selects a heating or cooling level (strength) based on how close the process temperature is to the setpoint.

The proportional parameter defines a band over what range of degrees the temperature controller will taper-off its heating or cooling. Heating/Cooling will be applied at 100% if the process temperature is more than the band parameter away from the setpoint. A smaller number will produce a more aggressive proportional response because it will shrink the band.

If the RQT Advanced is not providing a strong enough heating or cooling response for a given situation, this parameter number should be made more aggressive (a smaller number should be used).

PID Parameters (Continued)

Integral

Using only proportional control will cause the RQT Advanced to have steady-state error (it will never exactly reach setpoint). Integral response is used to eliminate this undesirable condition.

Integral logic introduces the awareness of the passage of time into the logic by looking into the past—and observing how far the process has been from the setpoint over time. The farther away the process is from setpoint for a longer and longer time, the more it causes the RQT Advanced to produce a stronger counter-response. Integral action is internally disabled whenever the RQT Advanced is further from setpoint than the Integral Active Band because it has no merit under this condition.

A smaller number will produce a more aggressive integral response. However, “0” will completely turn off integral response.

If the process temperature is approaching the setpoint too slowly, a stronger integral response (a smaller parameter number) can be used to remedy the situation. Too much integral response can cause the RQT Advanced temperature to severely oscillate.

Derivative

Derivative response is used to eliminate overshoot. It is also used to compensate for the slow-responding modulating valve. Like integral logic, it is aware of the passage of time—it looks forward into the future and anticipates if the machine will be overshooting the setpoint at some point in the future, based on current trends.

Derivative action is disabled whenever the RQT Advanced is far (further than twice the proportional band) from the setpoint.

A larger number will produce a more aggressive derivative response.

If the system temperature is overshooting the setpoint, try a more aggressive derivative response. If the system stutters or temporarily reverses temperature direction as approaching setpoint, your derivative response is too aggressive. If overshoot is not a concern, or you have a very large system, derivative control can be completely turned off by setting the parameter to “0” without negative consequences.

Manual Tuning Procedure

If you find yourself in a situation where the RQT Advanced is responding in an unpredictable manner, follow the procedure below to simplify the control loop and pick appropriate PID parameters.

PREREQUISITES:

- Your cooling water must be at a reasonably stable temperature and pressure.
- Your external heat load on the RQT Advanced must be reasonably constant.
- Select a setpoint for tuning that is similar to a typical setpoint for the process.
- You must have sufficient time to run your system through several thermal cycles in order to perform a full tuning.

PID Parameters (Continued)

STEPS:

To Start a Test

- 1** Navigate to the PID settings under the User Parameters window screen 7.
- 2** Turn off all derivative control by setting the D-Gain to “0”.
- 3** Minimize integral control by setting the I-Gain to “0”.
- 4** Set P-Band to an initial value of approximately 10% of setpoint.

Run a Test – Proportional

- 1** Start the RQT Advanced and observe it attempting to reach setpoint.
- 2** To access the screen to modify the PID band parameters, go to screen 7 of the user parameters window.
- 3** Decrease the PID - P Band until the system begins to oscillate around the setpoint. The PID P-Band is the temperature band over which the PID proportional response will be 100%. A smaller value produces a more aggressive PID proportional response. Example: if set to “5”, the unit will provide 100% cooling/heating response when 5 degrees away from setpoint.

 **NOTE:** You may have to cool down your system and repeat the experiment several times so you can accurately observe the process temperature approaching setpoint.

- 4** Multiply the value determined by Step 3 by “2” and enter it as the new P-Band.
- 5** Observe how closely the process value lags the setpoint in steady state. If it is close enough, no integral gain is needed and you may skip to the derivative testing section, Step 9. Otherwise, remember this lagging observation for the next section and continue to the next step.

Continue the Test - Proportional + Integral

- 6** Integral Active Band defines the band over which the integral response is active. Typically set to a similar value as the proportional band to prevent excessive integral windup.
- 7** Next, add in PID I-Gain for the PID controller. A default value of “25” is a reasonable starting point. A smaller number will produce a more aggressive integral response to eliminate steady state lagging error (however Zero will fully disable all integral response). This number should be small enough so that the process value exactly tracks the setpoint in steady state over time, but not so small that the system oscillates in steady state.

PID Parameters (Continued)

Continue the Test – Proportional + Integral + Derivative

- 8 Cool down your system and repeat the experiment so you can truly observe the process temperature approaching setpoint.** You will probably observe the temperature overshooting the setpoint. If overshoot is acceptable for your process, there is no reason to continue tuning and you may leave PID D-Gain disabled at zero. If you would like to eliminate overshoot in exchange for slightly longer times until setpoint is reached, overshoot can be eliminated using the next step.
- 9 Set the D-Gain to “10”.** Run the system through a thermal cycle and observe the overshoot the first time it reaches setpoint.
- 10 Double the PID D-Gain and run the machine through another thermal cycle.** If you have a modulating valve, you may wish to observe its position, since derivative control will also help the system properly anticipate the slow operating time for such a valve.
- 11 Repeat the doubling process of this parameter until overshoot is satisfactorily eliminated.** If the system stutters or temporarily reverses temperature direction as approaching setpoint, your derivative response is too aggressive and you need to decrease this parameter.

Finished

- 12 You should review your work and make sure your system is not on the verge of oscillating.** If your system oscillates intermittently, you probably have your gains too aggressive. It is better to be mild in your tuning than over-aggressive.
- 13 You are now finished tuning your system. Be sure to record your parameters PID B-Band, PID I-Gain, PID D-Gain, and Integral Active Band.** The parameters may need to be tweaked if your system or setpoint changes significantly.

Page intentionally left blank.

Appendix C

Plumbing Diagrams

Direct injection

In a direct injection arrangement, the cooling fluid is directly injected into the process loop whenever cooling is required. The immersion heater provides heat directly into the process fluid whenever needed.

DIRECT INJECTION RQT ADVANCED

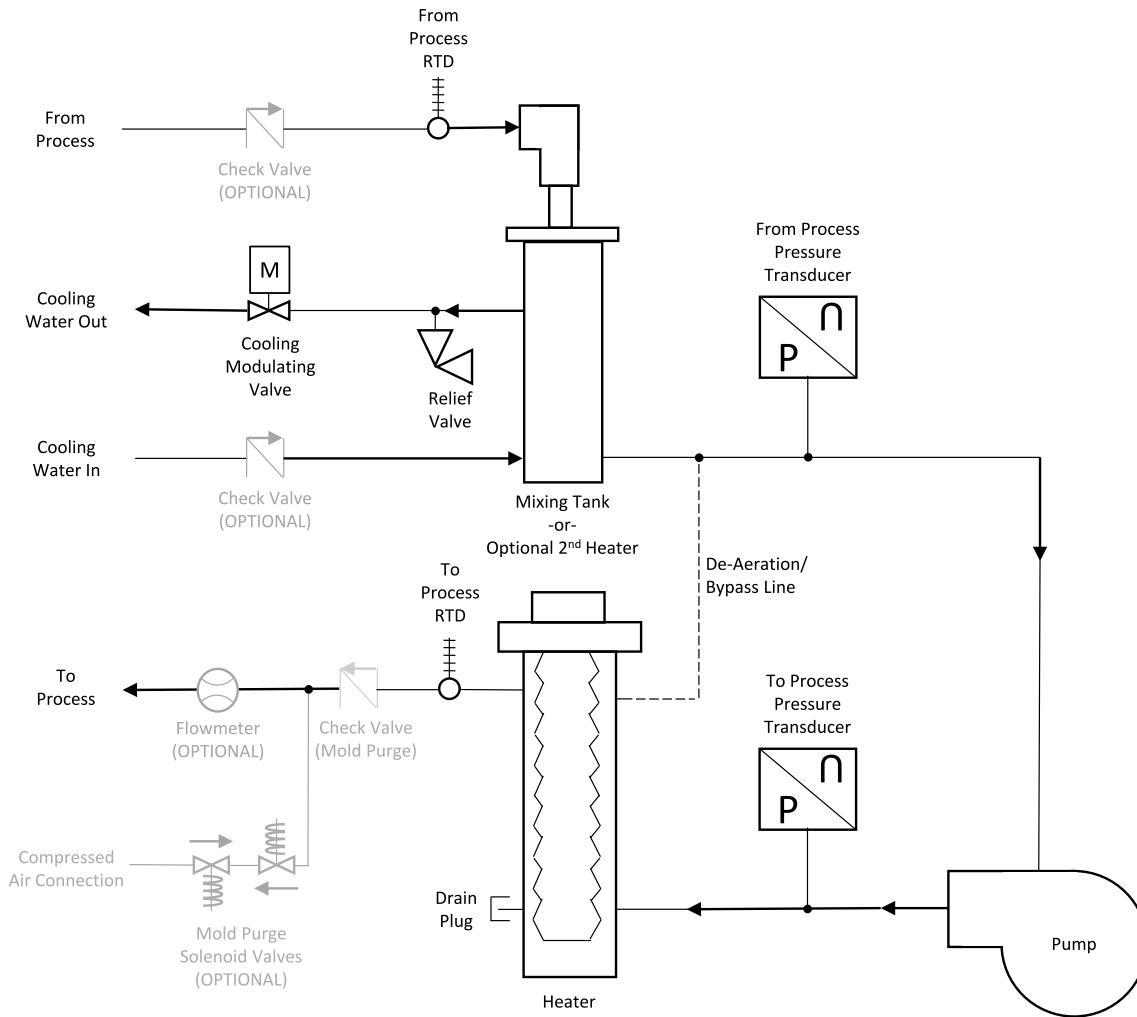

Plumbing Diagrams (Continued)

Closed-circuit common-source

In a closed-circuit common-source arrangement, the cooling fluid mixes with the process fluid only at initial filling. After that, there is very limited interaction of process and cooling water, and the cooling function is achieved by transferring heat through a heat exchanger. The immersion heater provides heat directly into the process fluid whenever needed.

CLOSED-CIRCUIT COMMON-SOURCE RQT ADVANCED

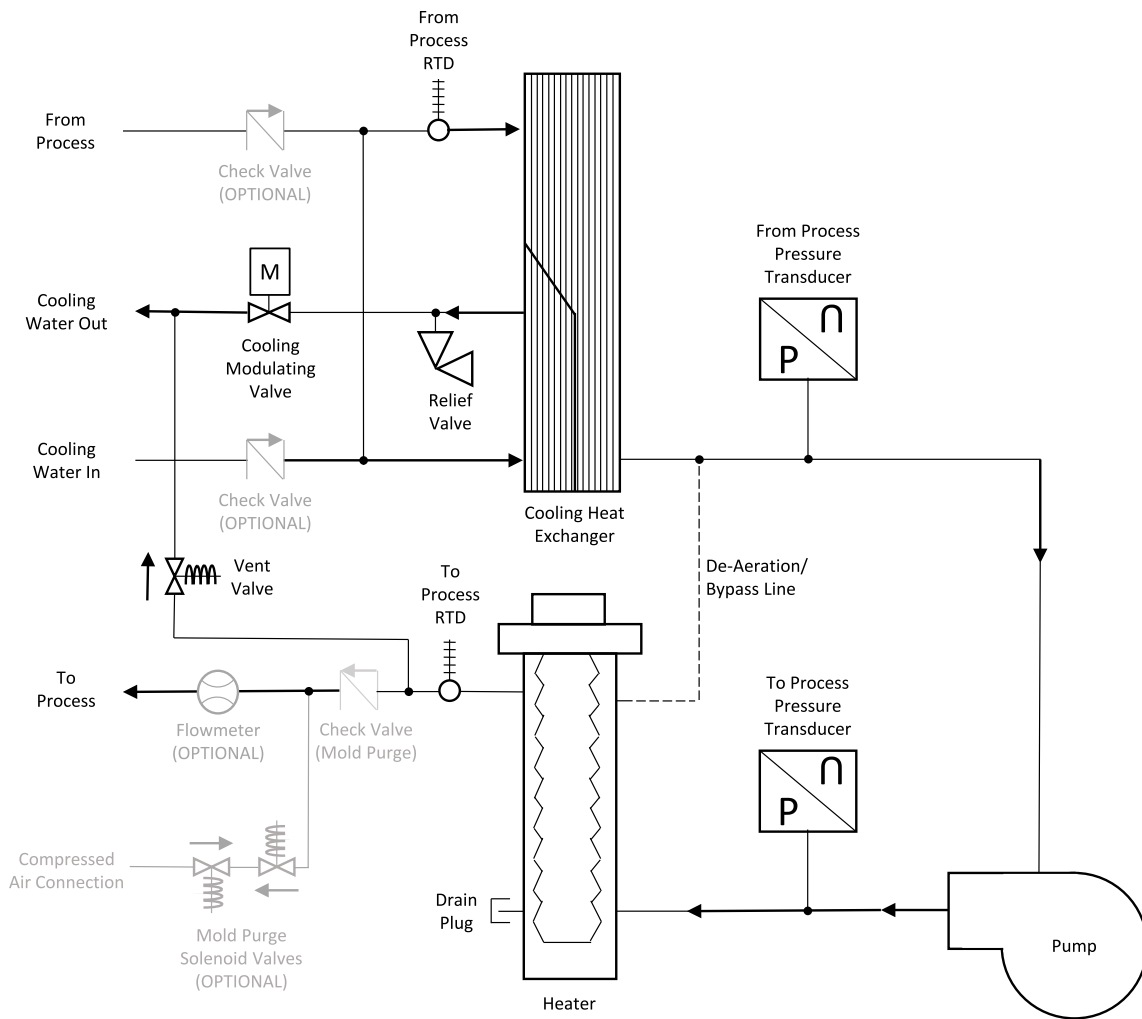

Plumbing Diagrams (Continued)

Direct Injection - In a direct injection arrangement, the cooling fluid is directly injected into the process loop whenever cooling is required. The immersion heater provides heat directly into the process fluid whenever needed.

DIRECT INJECTION RQT ADVANCED

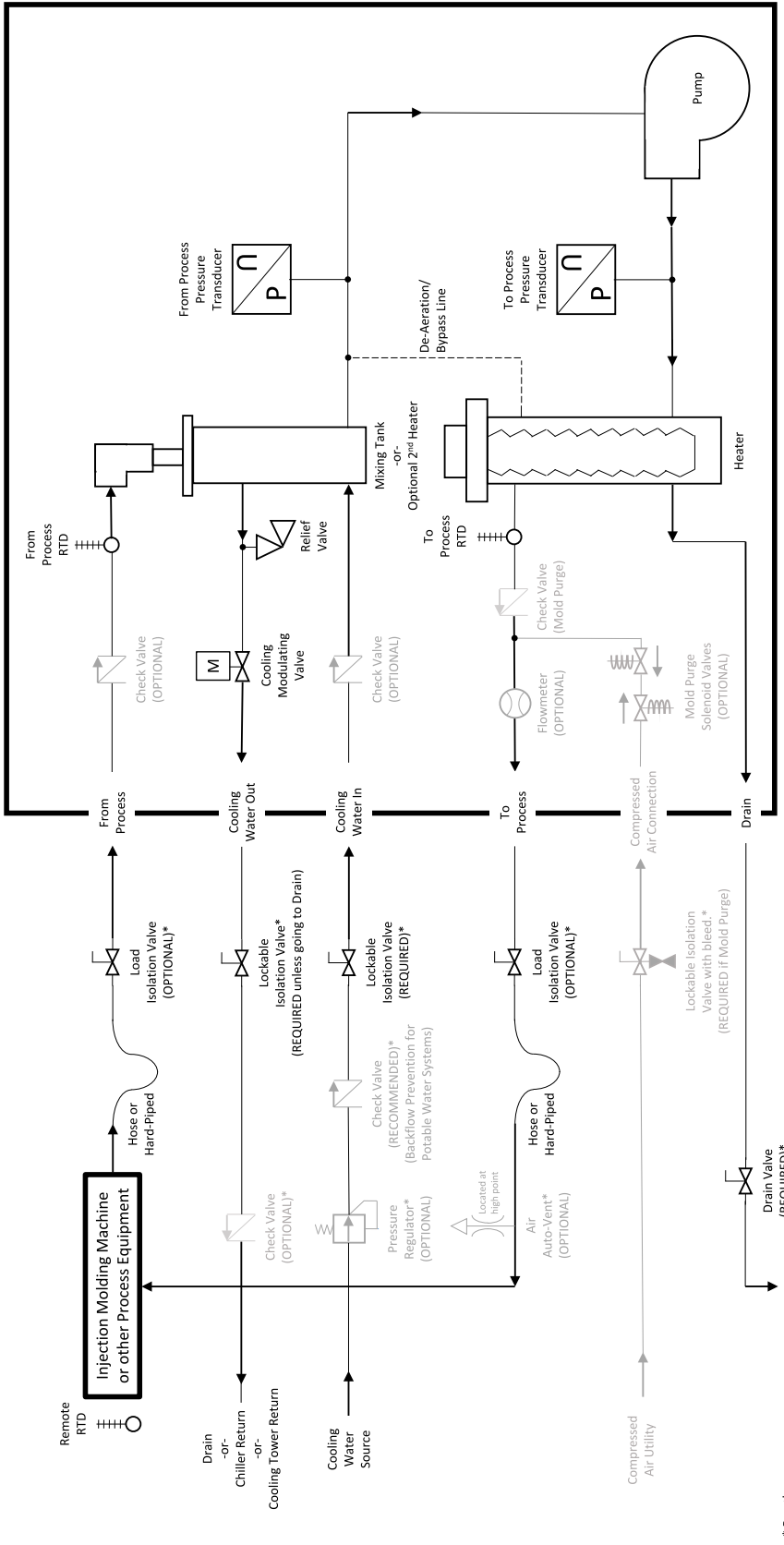

* By others

Revised 7-11-22

Plumbing Diagrams (Continued)

Closed-circuit common-source - In a closed-circuit common-source arrangement, the cooling fluid mixes with the process fluid only at initial filling. After that, there is very limited interaction of process and cooling water, and the cooling function is achieved by transferring heat through a heat exchanger. The immersion heater provides heat directly into the process fluid whenever needed.

CLOSED-CIRCUIT COMMON-SOURCE RQT ADVANCED

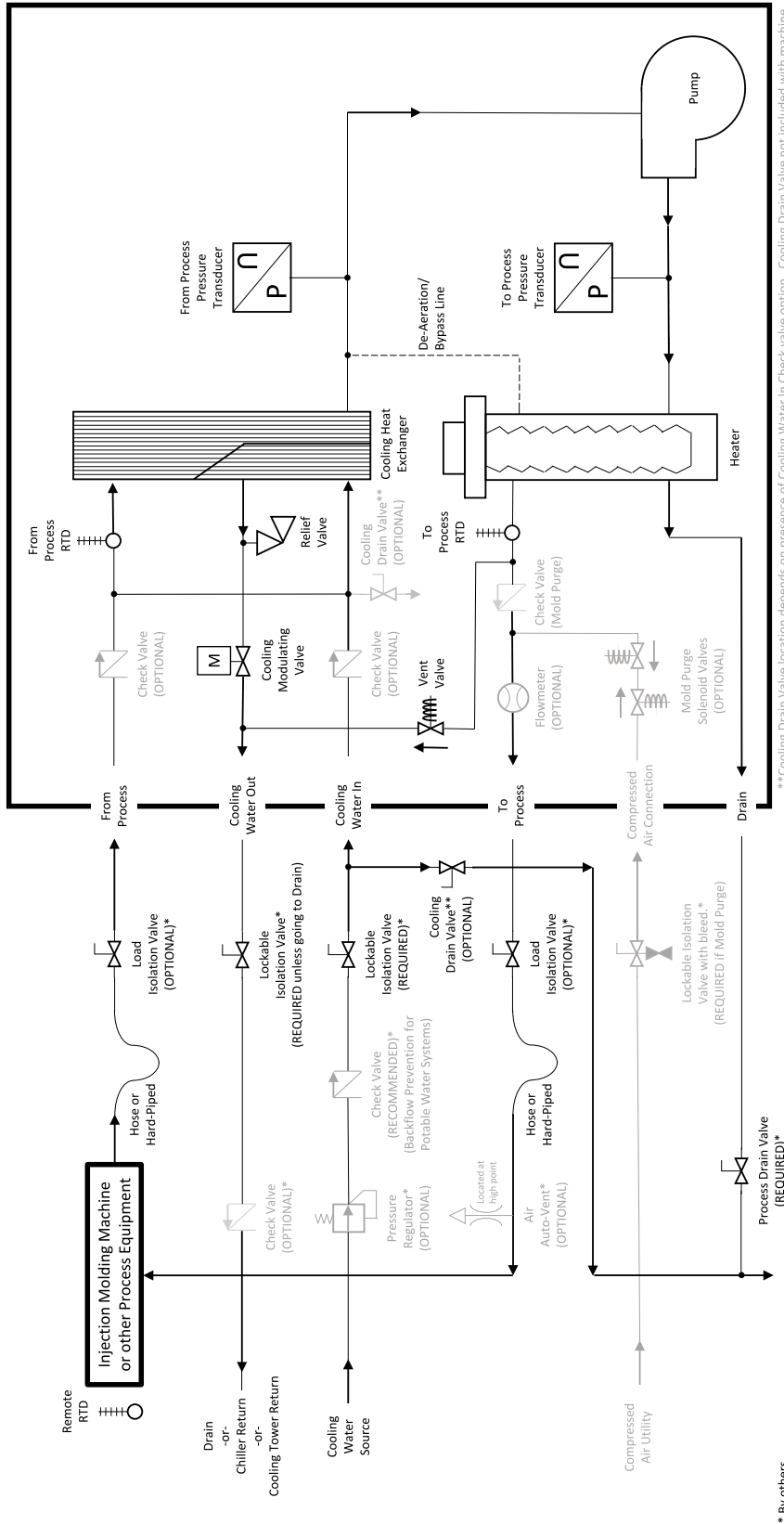

Revised 7-11-22

Plumbing Curves

Direct Injection

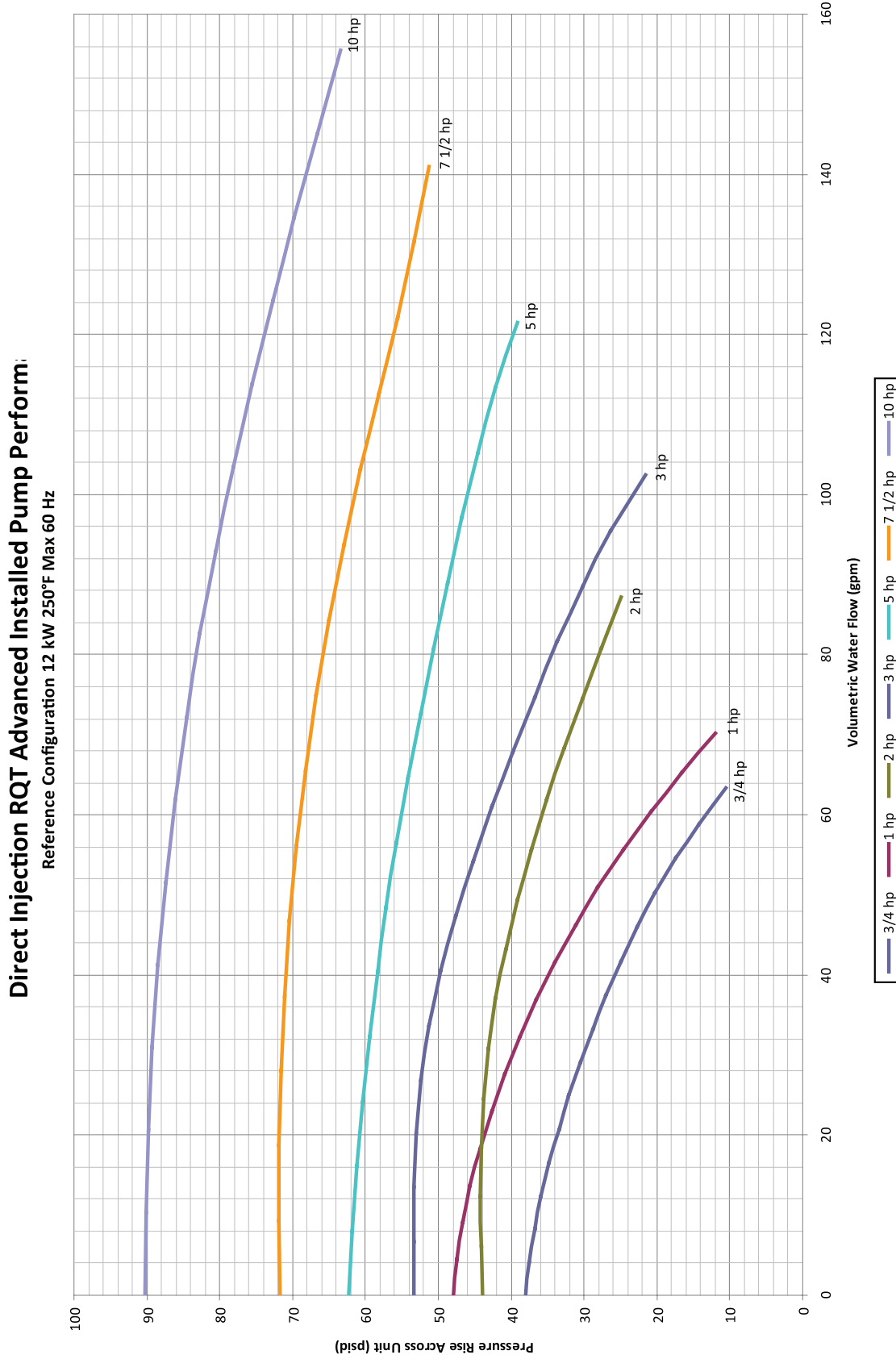

Plumbing Curves (Continued)

Closed Circuit Standard Performance

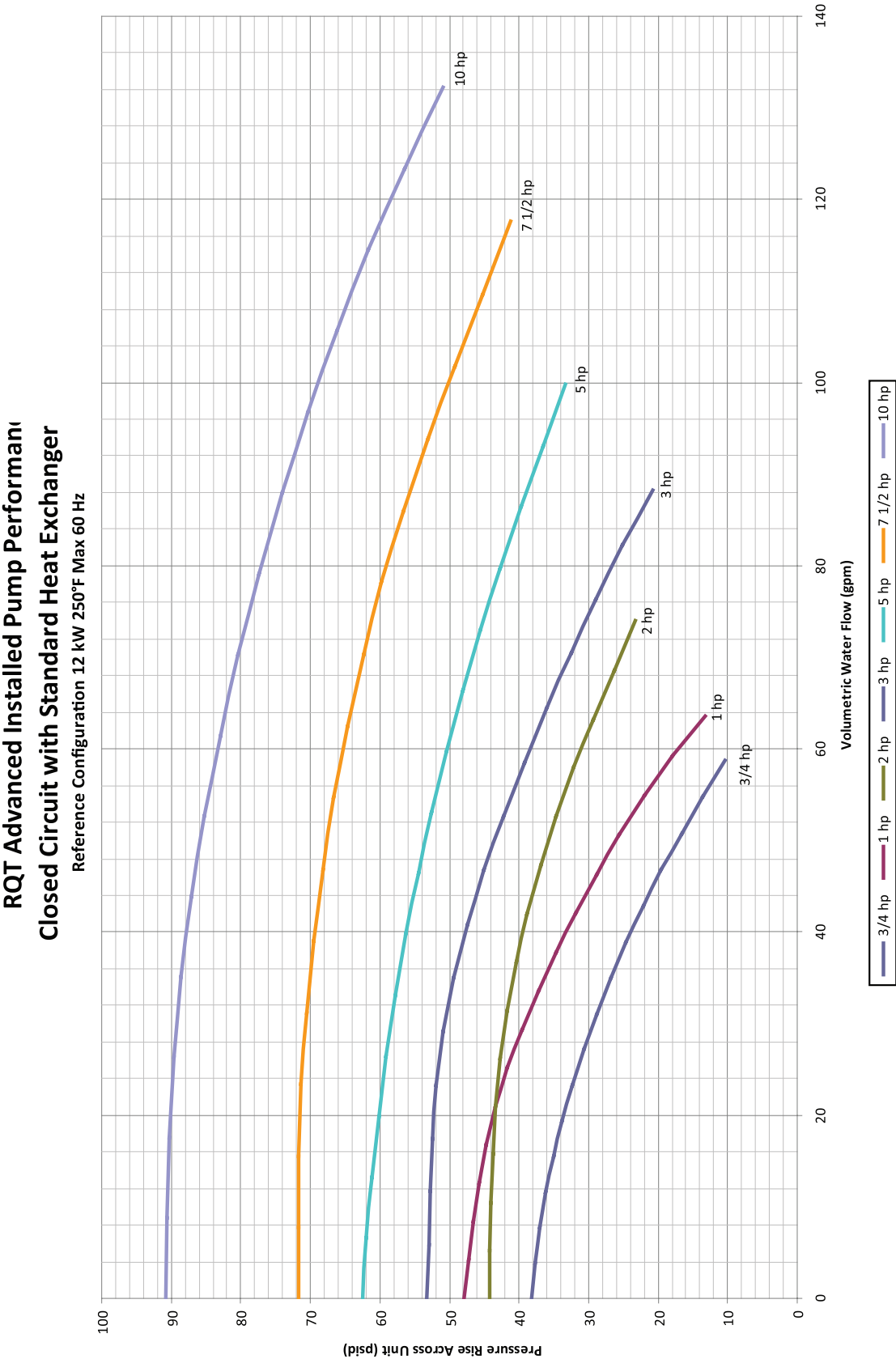

Appendix D

External Interfaces

Analog Remote Setpoint / Process Temp Retransmit

Connecting to the RQT Advanced





WARNING: Improper installation, operation, or servicing may result in equipment damage or personal injury.



External analog signals must be fully isolated from ground. Be sure to use fully isolated analog channels and/or power supplies. Analog wires must not be common or referenced to earth ground! Failure to heed this requirement will permanently damage the analog circuits in the TCU.

Wiring the Circuit

Sheet 4 and 5 on the electrical print illustrates the proper way to wire the remote interface. You can choose either 4-20mA or 0-10VDC, not both simultaneously for Remote Setpoint. Process Temp Retransmit is limited to 0-10 VDC only.

Circuit Impedance Requirements		
	0-10VDC	4-20mA
Remote Temperature Setpoint (Input)	50k Ω internal controller impedance.	50 Ω internal controller impedance.
	 NOTE: Voltage or loop current source must be supplied by the external interface.	
Process Temperature Retransmit (Output)	1k Ω minimum external impedance.	
	 NOTE: Voltage is self-generated by the TCU's temperature controller.	

Page intentionally left blank.

Appendix E

Flowmeter Installation Instruction Sheet

PRH021-0915

- 1** Remove the plumbing connection from the unit to the process.
- 2** Add sealant to threads and attach flow meter and fittings to the unit according to the figure below. The flow direction is indicated on the valve body. Make sure the meter is installed with the correct orientation.

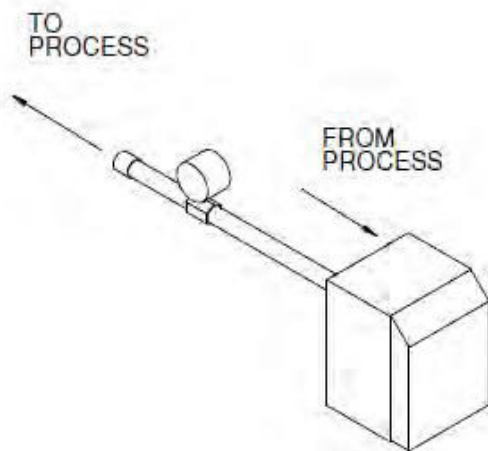

- 3** Reinstall all plumbing that was removed during installation.
- 4** Turn water on and check for leaks. Repair as required.
- 5** If the flowmeter has auxiliary contacts, reduce the process flow below the designated alarm threshold to test if they were set up properly.

Page intentionally left blank.

Appendix F

Modbus Parameters RQT Advanced Modbus Communication Registers

Modbus RTU default settings:	
Station ID:	1
Baudrate:	9600
Stop Bits:	1
Parity:	None
Data Length:	8

Modbus TCP/IP default settings:	
Port:	502
IP Address:	192.168.2.1
Subnet Mask:	255.255.255.0

Type	Index	Size	Variable Name	Data Type	De- fault Value	Min	Max	UoM	Security	Comments
Coil	0	1	b_NET_Cmd_Start	Bool				---none---	Read / Write	Network Start
Coil	1	1	b_NET_Cmd_Stop	Bool				---none---	Read / Write	Network Stop
HoldingRegister	100	1	w_NET_NetworkState	Word	0			---none---	Read / Write	0: Local writes setpoint; 1: Local/Remote writes setpoint (Remote contacted); 2: Remote writes setpoint
HoldingRegister	101	2	r_NET_Cmd_SetpointTemperature	Real				°C	Read / Write	Network Setpoint
InputRegister	100	2	r_NET_Sts_SetpointTemperature	Real				°C	Read	Setpoint Temperature
InputRegister	102	2	r_NET_Sts_ProcessValueTemperature	Real				°C	Read	ProcessValue Temperature
InputRegister	104	2	r_IN_SupplyRTD.Value	Real				°C	Read	To Process Temperature
InputRegister	106	2	r_IN_ReturnRTD.Value	Real				°C	Read	From Process Temperature
InputRegister	108	2	r_IN_LowPressure.Value	Real				psi	Read	From Process Pressure
InputRegister	110	2	r_IN_HighPressure.Value	Real				psi	Read	To Process Pressure
InputRegister	112	2	r_IN_RemoteRTD.Value	Real				°C	Read	Remote RTD Temperature
InputRegister	114	2	r_IN_AnalogSetpoint.Value	Real				°C	Read	Analog Setpoint Temperature
InputRegister	116	2	r_OUT_AnalogProcessRetransmit.Value	Real		0	100	%	Read	To Process Temperature Retransmit
InputRegister	118	2	r_OUT_ModulatingCoolingValve.Value	Real		0	100	%	Read	Modulating Cooling Valve

Modbus Parameters (Continued)

RQT Advanced Modbus Communication Registers

Type	Index	Size	Variable Name	Data Type	De-fault Value	Min	Max	UoM	Security	Comments
InputRegister	120	2	r_AvgFlow	Real	0.0			gpm	Read	Estimated Average Flow
DiscreteInput	0	1	b_ALM_Overtemperature.Value	Bool				---none---	Read	
DiscreteInput	1	1	b_ALM_HeaterContactorStuckClosed.Value	Bool				---none---	Read	
DiscreteInput	2	1	b_ALM_HeaterContactorStuckOpen.Value	Bool				---none---	Read	
DiscreteInput	3	1	b_ALM_PumpContactorStuckClosed.Value	Bool				---none---	Read	
DiscreteInput	4	1	b_ALM_PumpContactorStuckOpen.Value	Bool				---none---	Read	
DiscreteInput	5	1	b_ALM_PumpOverload.Value	Bool				---none---	Read	
DiscreteInput	6	1	b_ALM_UserTempHigh.Value	Bool				---none---	Read	
DiscreteInput	7	1	b_ALM_UserTempLow.Value	Bool				---none---	Read	
DiscreteInput	8	1	b_ALM_FactoryTempHigh.Value	Bool				---none---	Read	
DiscreteInput	9	1	b_ALM_FactoryTempLow.Value	Bool				---none---	Read	
DiscreteInput	10	1	b_ALM_LowPressureStandbyTimeout.Value	Bool				---none---	Read	
DiscreteInput	11	1	b_ALM_LowPressureStrikeout.Value	Bool				---none---	Read	
DiscreteInput	12	1	b_ALM_PhaseMonitor.Value	Bool				---none---	Read	
DiscreteInput	13	1	b_ALM_SupplySensorOpenError.Value	Bool				---none---	Read	
DiscreteInput	14	1	b_ALM_SupplySensorShortedError.Value	Bool				---none---	Read	
DiscreteInput	15	1	b_ALM_SupplySensorOtherError.Value	Bool				---none---	Read	
DiscreteInput	16	1	b_ALM_ReturnSensorOpenError.Value	Bool				---none---	Read	
DiscreteInput	17	1	b_ALM_ReturnSensorShortedError.Value	Bool				---none---	Read	
DiscreteInput	18	1	b_ALM_ReturnSensorOtherError.Value	Bool				---none---	Read	
DiscreteInput	19	1	b_ALM_RemoteSensorOpenError.Value	Bool				---none---	Read	
DiscreteInput	20	1	b_ALM_RemoteSensorShortedError.Value	Bool				---none---	Read	
DiscreteInput	21	1	b_ALM_RemoteSensorOtherError.Value	Bool				---none---	Read	
DiscreteInput	22	1	b_ALM_AnalogSetpointHighError.Value	Bool				---none---	Read	
DiscreteInput	23	1	b_ALM_AnalogSetpointLowError.Value	Bool				---none---	Read	

Modbus Parameters (Continued)

RQT Advanced Modbus Communication Registers

Type	Index	Size	Variable Name	Data Type	De-fault Value	Min	Max	UoM	Security	Comments
DiscreteInput	24	1	b_ALM_AnalogSetpointOtherError.Value	Bool				---none---	Read	
DiscreteInput	25	1	b_ALM_NetworkSetpointHighError.Value	Bool				---none---	Read	
DiscreteInput	26	1	b_ALM_NetworkSetpointLowError.Value	Bool				---none---	Read	
DiscreteInput	27	1	b_ALM_NetworkSetpointHeartbeatError.Value	Bool				---none---	Read	
DiscreteInput	28	1	b_ALM_HighDeviation.Value	Bool				---none---	Read	
DiscreteInput	29	1	b_ALM_LowDeviation.Value	Bool				---none---	Read	
DiscreteInput	30	1	b_ALM_Flow_HighDeviation.Value	Bool				---none---	Read	
DiscreteInput	31	1	b_ALM_Flow_LowDeviation.Value	Bool				---none---	Read	
DiscreteInput	32	1	b_ALM_PressureBelowMinimum.Value	Bool				---none---	Read	
DiscreteInput	33	1	b_ALM_PressureNotHighEnough.Value	Bool				---none---	Read	
DiscreteInput	34	1	b_WRN_PumpOverload.Value	Bool				---none---	Read	
DiscreteInput	35	1	b_WRN_SupplySensorOpenError.Value	Bool				---none---	Read	
DiscreteInput	36	1	b_WRN_SupplySensorShortedError.Value	Bool				---none---	Read	
DiscreteInput	37	1	b_WRN_SupplySensorOtherError.Value	Bool				---none---	Read	
DiscreteInput	38	1	b_WRN_ReturnSensorOpenError.Value	Bool				---none---	Read	
DiscreteInput	39	1	b_WRN_ReturnSensorShortedError.Value	Bool				---none---	Read	
DiscreteInput	40	1	b_WRN_ReturnSensorOtherError.Value	Bool				---none---	Read	
DiscreteInput	41	1	b_WRN_FlashMemoryWrites.Value	Bool				---none---	Read	
DiscreteInput	42	1	b_WRN_HighDeviation.Value	Bool				---none---	Read	
DiscreteInput	43	1	b_WRN_LowDeviation.Value	Bool				---none---	Read	
DiscreteInput	44	1	b_WRN_Flow_HighDeviation.Value	Bool				---none---	Read	
DiscreteInput	45	1	b_WRN_Flow_LowDeviation.Value	Bool				---none---	Read	
DiscreteInput	46	1	b_WRN_PressureBelowMinimum.Value	Bool				---none---	Read	
DiscreteInput	47	1	b_WRN_PressureNotHighEnough.Value	Bool				---none---	Read	
DiscreteInput	48	1	b_WRN_SetpointTooHighForPressure.Value	Bool				---none---	Read	

Page intentionally left blank.